



HAVALANDIRMA ÇÖZÜMLERİ
VENTILATION SOLUTIONS



FİYAT LİSTESİ / PRICE LIST

2026 / 01



SATIŞ VE GARANTİ ŞARTLARI

Firmamız, ihbar etmeksizin fiyatları değiştirme hakkını saklı tutar.

Firmamız, üretmiş olduğu ürünlerin teknik özellikleri ve ölçülerini değiştirme hakkını saklı tutar. Firmamıza bu sebeple rücu edilemez.

Güçtay ve Wispy markalı ürünler, imalat hatalarına karşı 2 (iki) yıl garantilidir.

İmalat hatalarından kaynaklı arızalı ürünler, faturanın ibrazı ile tamir edilecektir. Faturanın İBRAZI yapılmayan ürünlerin, tamir masrafı, bayiye fatura edilecektir.

Garanti kapsamında olup, firmamıza gönderilecek arızalı ürünler için, tamir irsaliyesinin düzenlenmesi şarttır. Düzenlenecek irsaliyede, "tamir amaçlı gönderilmiştir; fatura edilmeyecektir.", ibaresi olmak zorundadır.

Satış faturası ve irsaliye düzenlenerek gelen arızalı ürünlerin tamir süresi, 20 (YİRMİ) gündür. Ancak müşteri memnuniyeti gözetilerek maksimum 1 (bir) hafta içerisinde, ürünlerin tamiri yapıp, sevkiyatı yapılacaktır.

Arızalı ürünlerin firmamıza sevkiyatında ürün nakliye masrafı tüketiciye aittir. Nakliyesi ödenmeyen gönderimler teslim alınmayacaktır.

Arızalı olarak firmamıza gelen ürünler kullanılmış ise; hiçbir şartta yenisi ile değiştirilemez. Ürünlerin aşırı kirli, yağlı, kurum bağlamış vb. şekilde gelmesi durumunda temizlenmesi ve bakımı ücrete tabi olur.

Bazı ürünlerimizde kullanmakta olduğumuz, **HARİCİ motorlar, üretici firma garantisi altındadır. Arıza durumunda üretici firma garanti şartları geçerlidir. Bu tip motorlara gelebilecek fiyat farkı, ürünlerimizin satış fiyatına direkt olarak yansıtılacaktır.**

Fiyatlarımıza K.D.V. dahil değildir. Ürünler fabrika teslimdir.

Nakliye esasında oluşabilecek hasar ve zararlar müşteri sorumluluğundadır.

Müşteri odaklı vermiş olduğumuz hizmetin aksamaması ve bu hizmetin devamlılığının sağlanması için yukarıdaki şartlara uyulmasını rica eder, firmamıza göstermiş olduğunuz ilgiye teşekkür ederiz.

BANKA HESAP NUMARALARIMIZ

YKB TUZLA OSB ŞUBE IBAN: TR75 0006 7010 0000 0052 9671 50

HALKBANKASI ŞERİFALİ ŞUBE IBAN: TR44 0001 2001 2740 0010 1000 46

ÜRÜNLER / PRODUCTS	SAYFA/PAGE
 PLASTİK DEKORATİF FANLAR / PLASTIC DECORATIF FANS	1
 AKSİYAL KAPAKLI FANLAR / AXIAL FANS WITH COVER	11
 AKSİYAL BACA - DUVAR FANLARI / AXIAL WALL FANS	12
 AKSİYAL SANAYİ FANLARI / AXIAL INDUSTRIAL FANS	15
 AKSİYAL KARE TİP SANAYİ FANLARI / SQUARE TYPE AXIAL INDUSTRIAL FANS	18
 AKSİYAL SANAYİ FANLARI(HP MOTORLU) / AXIAL INDUSTRIAL FANS WITH HP MOTORS	19
 AKSİYAL KARE KASALI PLASTİK PERVELNELİ FANLAR / AXIAL PLASTIC PROPELLER SQUARE FANS	20
 AKSİYAL SOĞUTMA FANLARI / EXTERNAL MOTOR AXIAL WALL TYPE FANS	22
 AKSİYAL DUVAR TİPİ YUVARLAK FANLAR / TERNAL MOTOR AXIAL WALL TYPE FANS	23
 AKSİYAL DUVAR TİPİ KARE FANLAR / EXTERNAL MOTOR AXIAL WALL TYPE SQUARE FANS	24
 AKSİYAL BORU TİPİ FANLAR / EXTERNAL MOTOR AXIAL DUCT TYPE FANS	25
 AKSİYAL BASINÇLANDIRMA FANLARI / AXIAL PRESSURE FANS	26
 AKSİYAL DUMAN EGZOZ FANLARI / AXIAL SMOKE EXHAUST FANS	27
 AKSİYAL SERA SİRKÜLASYON FANLARI / AXIAL GREENHOUSE CIRCULATION FANS	28
 AKSİYAL HAVALANDIRMA FANLARI / AXIAL VENTILATIONS FANS	30
 VANTİLATÖRLER / VENTILATORS	32
 ÇİFT YÖNLÜ PLASTİK FANLAR / BIDIRECTIONAL PLASTIC FANS	35
 KARMA AKIŞLI PLASTİK FANLAR / IN-LINE PLASTIC DUCT FANS	36
 YUVARLAK KANAL TİPİ RADYAL FANLAR / DUCT FANS	37
 DİKDÖRTGEN KANAL TİPİ RADYAL FANLAR / RECTANGULAR DUCT FANS	39
 ÇATI FANLARI / ROOF FANS	41
 RADYAL FANLAR / RADIAL FANS	46
 HÜCRELİ FANLAR / CELL FANS	56
 YEDEK PARÇALAR / SPARE PARTS	58



PLASTİK DEKORATİF FANLAR

Plastic Decorative Fans

GENEL AÇIKLAMA

Modern, ince, zarif bir görünüme sahiptirler. Havayı doğrudan dışarıya ya da kısa bir boruya verecek şekilde tasarlanmıştır. Maksimum uzunluk 3 metredir. Tuvaletler, banyolar, duş kabinler, kalorifer dairesi ve mutfaklar için uygundur. Duvara, pencereye, panele ve tavana kolaylıkla monte edilebilir. Ekonomik seri dışındaki ürünler, yüksek kalite plastik ve malzemeden üretilmiştir. Sabit 12gara vardır. Motorun uzun ömürlü olması ve sessiz çalışmasını sağlayan, bakım gerektiren kendini yağlayan küresel yatak bulunmaktadır. Aşırı ısınmaya karşı termik sigorta korumalı motor (230V - 50Hz.) kullanılmıştır. Bakımı ve temizliği kolaydır. Enerji tasarrufu sağlayacak şekilde üretilmiştir. Fanlar EN 60335-2-80, EC Directive standartlarındadır. Maksimum 50°C ortam havasını temizlemek için kullanılır. Ekonomik seri harici ürünler IPX4 koruma sınıfına sahiptirler.

GENERAL DESCRIPTION

Modern, slim stylish profile to provide an easy installation. Exhausts air directly outwards or to short ducts (max 3 m length) Suitable for toilets, bathrooms, shower-rooms, utility rooms and kitchens. For wall, window, panel and ceiling installation. Products outside the economy series are made from high-quality plastics and materials. All models are complete with back drought shutter and neon running light. Maintenance free, self lubricating sleeve bedding motor for long life and noisless operation. Easy maintenance and cleaning. Desing to ensure energy saving. Fans comply with EN 60335-2-80, EC Low Voltage Directive 73/23-93/68 and EC Directiv. They are desinged for clean air with maximum temperature 50°C The economy series external products have an IPX4 protection rating.



GDSF DEKORATİF SESSİZ FANLAR

Decorative Silent Fans

*Kullanımı düşük ses seviyesi nedeni ile rahatsızlık vermez.

*Its use does not cause discomfort due to its low sound level.

FAN VERİLERİ | DATA

Tip/Typ	Voltaj Voltage	Frekans	Güç Power	Debi Air Flow	Devir Speed	Ses seviyesi Sound level	Ağırlık Weight Net	Ağırlık Weight Gross	Pieces Box	İç Kutu Ölç. Inner Box Size	Dış Kutu Ölç. Outer Box Size	Fiyat/Price
	V	Hz	Watt	m ³ /saat	R.p.m.	(DB(A))	Kg	Kg	Ad.	mm	mm	Usd
GDSF10	230	50	8,4	90	2.800	25	0,43	0,52	12	104*160*160	624*320*160	\$55
GDSF12	230	50	10	170	2.800	30	0,5	0,61	12	104*180*180	624*360*180	\$75
GDSF15	230	50	20	320	2.800	33	0,65	0,75	12	104*210*200	624*420*400	\$130

* Klepeli

TEKNİK ÇİZİM | TECHNICAL DRAWING

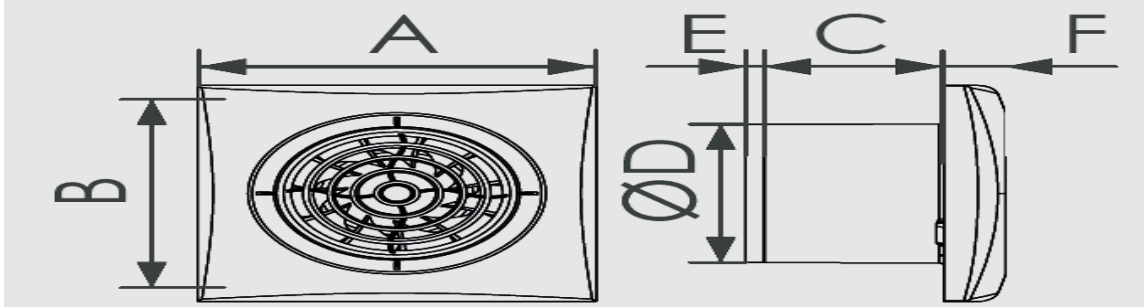

TEKNİK ÖLÇÜLER | TECHNICAL DIMENSIONS

Tüm Ölçüler mm'dir. | All dimensions are in mm

Tip / Type	A	B	C	D	E Klepe Ölçüsü	F
GDSF10	155	135	70	100	7	24
GDSF12	175	155	78	125	8,5	24
GDSF15	205	183	108	149		24

PERFORMANS VERİLERİ | PERFORMANCE DATA

GDSF10

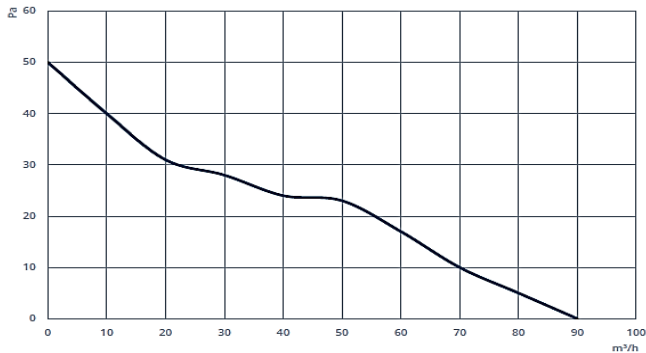

GDSF12

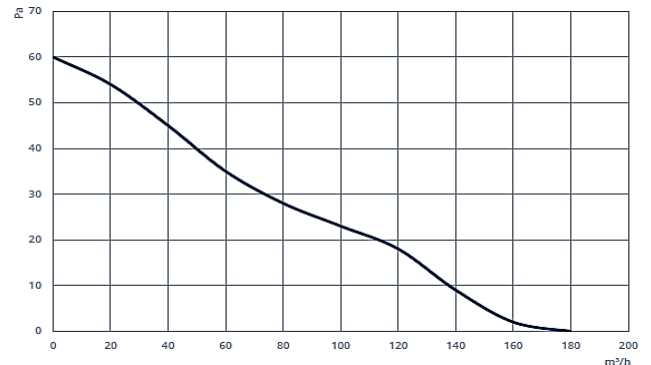



GPE DEKORATİF FANLAR

Decorative fans

OPSİYONLAR:

- 110V - 60 Hz İndüksiyon Motoru
- Zaman Ayarı (1 - 60 dk. Arasında Ayarlanabilir)
- İpli Çalıştırma Sistemi
- SELV (12V AC)

OPTIONS

- 110V - 60 Hz Induction Motor
- Timer (Adjustable form 1 to 60 minutes)
- Pull Cord
- SELV (12V AC)



FAN VERİLERİ | DATA

Tip/Typ	Voltaj Voltage	Frekans	Güç Power	Debi Air Flow	Devir Speed	Akım Current	Ağırlık Weight Net	Ağırlık Weight Gross	Pieces Box	İç Kutu Ölç. Inner Box Size	Dış Kutu Ölç. Outer Box Size	Fiyat/Price
	V	Hz	Watt	m ³ /saat	R.p.m.	A	Kg	Kg	Ad.	mm	mm	Usd
GPE10	230	50	14	100	2.800	0,07	0,36	0,42	12	100*155*155	600*310*155	\$13,85
GPE12	230	50	25	170	2.800	0,14	0,43	0,51	12	100*175*175	600*350*175	\$16,00
GPE15	230	50	30	300	2.800	0,18	0,60	0,70	12	102*215*215	630*430*215	\$20,00

TEKNİK ÇİZİM | TECHNICAL DRAWING

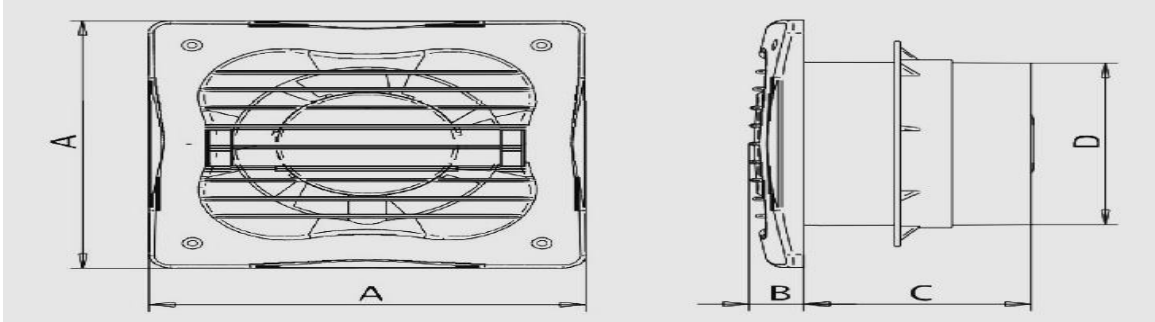

TEKNİK ÖLÇÜLER | TECHNICAL DIMENSIONS

Tüm Ölçüler mm'dir. | All dimensions are in mm

Tip / Type	A	B	C	D
GPE10	150	20	77	98
GPE12	170	23	74	118
GPE15	210	25	72	154

PERFORMANS VERİLERİ | PERFORMANCE DATA

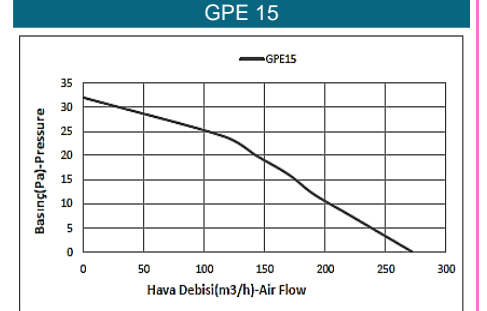
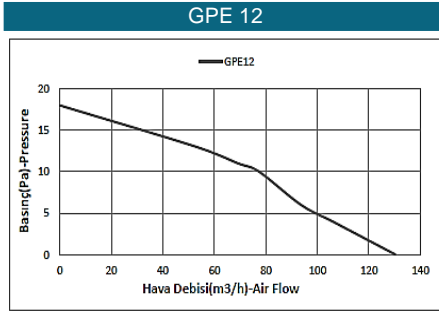
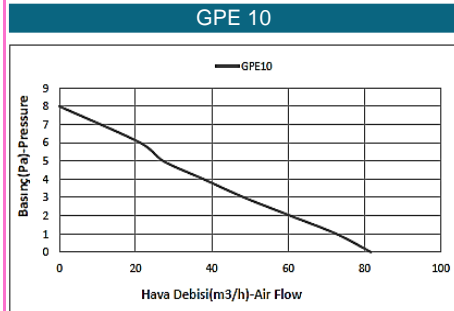



GES DEKORATİF FANLAR

GÜÇTAY®
EKONOMİK SERİ

Decorative fans

OPSİYONLAR



Beyaz



Gri



Siyah

*1 yıl garanti

FAN VERİLERİ | DATA

Tip/Typ	Voltaj Voltage	Frekans	Güç Power	Debi Air Flow	Devir Speed	Akım Current	Ağırlık Weight Net	Ağırlık Weight Gross	Pieces Box	İç Kutu Ölç. Inner Box Size	Dış Kutu Ölç. Outer Box Size	Fiyat/Price
	V	Hz	Watt	m³/saat	R.p.m.	A	Kg	Kg	Ad.	mm	mm	Usd
GES10	230	50	15	90	2.500	0,010	0,36	0,42		100*155*155		\$11,00
GES12	230	50	20	160	2.500	0,096	0,43	0,51		100*175*175		\$13,00
GES15	230	50	25	290	2.500	0,011	0,60	0,70		102*215*215		\$15,00
GES20	230	50	30	450	2.800	0,30	1,34	1,55		135*280*280		\$40,00
OPSİYONLAR												
GES10KB	230	50	15	90	2.500	0,010	0,4	0,47		99*159*159		\$12,00
GES12KB	230	50	20	160	2.500	0,096	0,44	0,54		95*189*189		\$14,00
GES15KB	230	50	25	290	2.500	0,011	0,58	0,69		107*225*224		\$15,00
GES10KG	230	50	15	90	2.500	0,010	0,4	0,47		99*159*159		\$13,00
GES12KG	230	50	20	160	2.500	0,096	0,44	0,54		95*189*189		\$15,00
GES15KG	230	50	25	290	2.500	0,011	0,58	0,69		107*225*224		\$17,00
GES10KS	230	50	15	90	2.500	0,010	0,4	0,47		99*159*159		\$13,00
GES12KS	230	50	20	160	2.500	0,096	0,44	0,54		95*189*189		\$15,00
GES15KS	230	50	25	290	2.500	0,011	0,58	0,69		107*225*224		\$17,00

TEKNİK ÖLÇÜLER | TECHNICAL DIMENSIONS

Tüm Ölçüler mm'dir. | All dimensions are in mm

Tip / Type	A	B	C	D	E
GES10	150	20	77	98	
GES12	170	23	74	118	
GES15	210	25	72	154	
OPSİYONLAR					
10'LUK	98	159	159	12	65
12'LİK	118	188	188	14	77
15'LİK	148	220	220	16	90



GD10E DEKORATİF FAN

Decorative fan

OPSIYONLAR:

- 110V - 60 Hz İndüksiyon Motoru
- SELV (12V AC)

OPTIONS

- 110V - 60 Hz Induction Motor
- SELV (12V AC)



FAN VERİLERİ | DATA

Tip/Typ	Voltaj Voltage	Frekans	Güç Power	Debi Air Flow	Devir Speed	Akım Current	Ağırlık Weight Net	Ağırlık Weight Gross	Pieces Box	İç Kutu Ölç. Inner Box Size	Dış Kutu Ölç. Outer Box Size	Fiyat/Price
	V	Hz	Watt	m ³ /saat	R.p.m.	A	Kg	Kg	Ad.	mm	mm	Usd
GD10E	230	50	14	100	2,8	0,07	0,34	0,39	12	85*135*135	510*270*135	\$13,34

TEKNİK ÇİZİM | TECHNICAL DRAWING

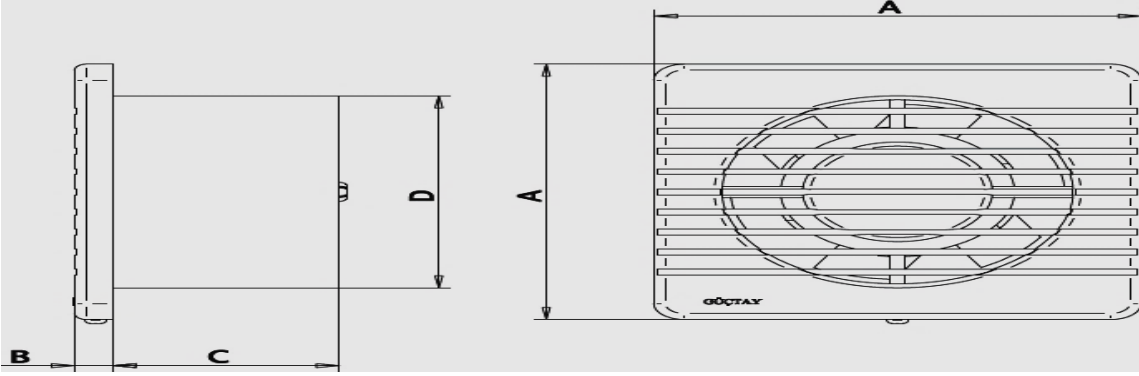

TEKNİK ÖLÇÜLER | TECHNICAL DIMENSIONS

Tüm Ölçüler mm'dir. | All dimensions are in mm

Tip / Type	A	B	C	D
GD10E	127	10	59	95

PERFORMANS VERİLERİ | PERFORMANCE DATA

GD10E

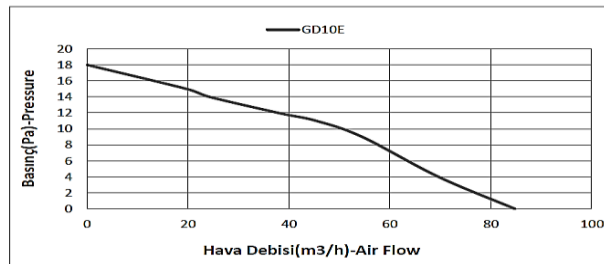



GWD DEKORATİF İNCE MODEL FANLAR

Decorative Slim Model Fans



Wispy®

OPSİYONLAR:

- 110V - 60 Hz İndüksiyon Motoru
- SELV (12V AC)

OPTIONS

- 110V - 60 Hz Induction Motor
- SELV (12V AC)

TERMİK
KORUMALI
MOTOR



FAN VERİLERİ | DATA

Tip/Typ	Voltaj Voltage	Frekans	Güç Power	Debi Air Flow	Devir Speed	Akım Current	Ağırlık Weight Net	Ağırlık Weight Gross	Pieces Box	İç Kutu Ölç. Inner Box Size	Dış Kutu Ölç. Outer Box Size	Fiyat/Price
	V	Hz	Watt	m³/saat	R.p.m.	A	Kg	Kg	Ad.	mm	mm	Usd
GWD 10	230	50	14	100	2.800	0,07	0,39	0,46	12	75*170*170	450*340*170	\$18,30
GWD 12	230	50	25	170	2.800	0,14	0,52	0,62	12	90*211*210	540*422*210	\$19,95
GWD 15	230	50	30	300	2.800	0,18	0,70	0,83	12	90*247*247	540*494*247	\$23,00

TEKNİK ÇİZİM | TECHNICAL DRAWING

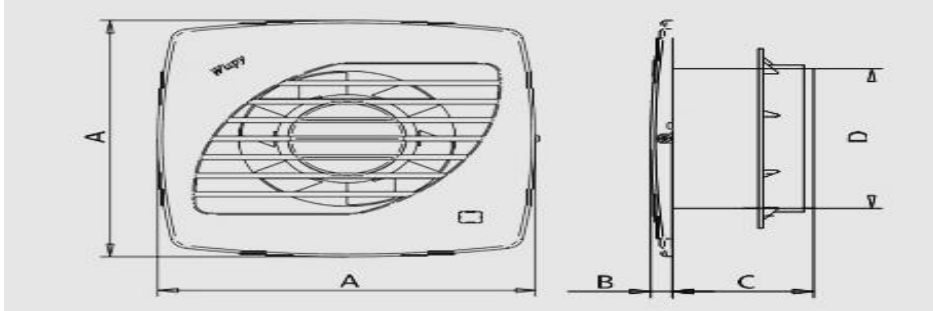

TEKNİK ÖLÇÜLER | TECHNICAL DIMENSIONS

Tüm Ölçüler mm'dir. | All dimensions are in mm

Tip / Type	A	B	C	D
GWD 10	166	10	61,5	98
GWD 12	205	11,5	72,5	118
GWD 15	235	12	71	148

PERFORMANS VERİLERİ | PERFORMANCE DATA

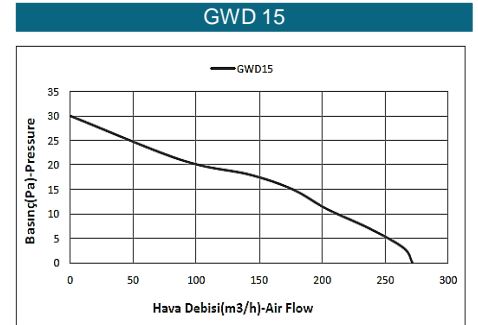
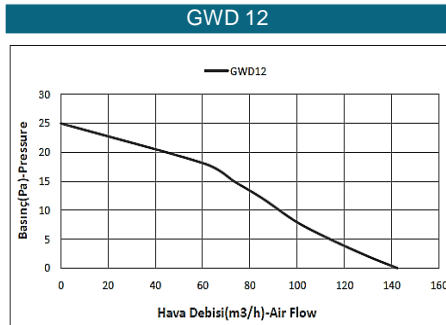
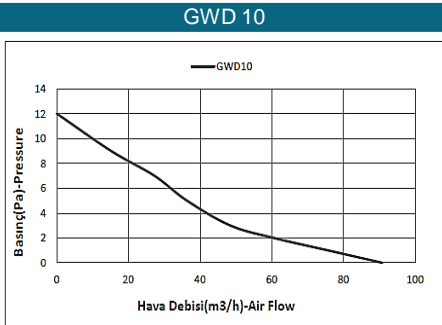

**GWM 10
GWM12**

GWM 15

Wispy®

GWM OTOMATİK PANJURLU DEKORATİF FANLAR

Decorative Automatic Shutter Fans

*Termal aktüatörle çalışan elektrikli iç kapakları olan otomatik aksiyel fanlardır.
*Yavaşlatılmış sessiz kapak hareketi bulunmaktadır.

- Automatic axial fans provided with electrical internal shutters, operating via a thermal actuator,
- Delayed and silent shutter moving.

OPSIYONLAR:

- 110V - 60 Hz İndüksiyon Motoru
- Zaman Ayarı (1 - 60 dk. Arasında Ayarlanabilme)
- Hareket sensörü
- İpli Çalıştırma Sistemi
- SELV (12V AC)

OPTIONS

- 110V - 60 Hz Induction Motor
- Timer (Adjustable form 1 to 60 minutes)
- Motion Sensor
- Pull Cord
- SELV (12V AC)

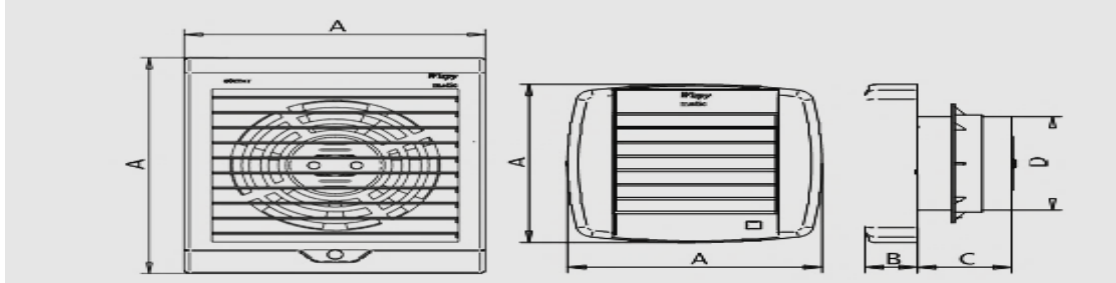

FAN VERİLERİ | DATA

Tip/Typ	Voltaj Voltage	Frekans	Güç Power	Debi Air Flow	Devir Speed	Akım Current	Ağırlık Weight Net	Ağırlık Weight Gross	Pieces Box	İç Kutu Ölç. Inner Box Size	Dış Kutu Ölç. Outer Box Size	Fiyat/Price
	V	Hz	Watt	m³/saat	R.p.m.	A	Kg	Kg	Ad.	mm	mm	Usd
GWM 10	230	50	14	100	2.800	0,08	0,51	0,59	12	105*173*175	630*346*175	\$28,30
GWM 12	230	50	25	170	2.800	0,14	0,64	0,75	12	110*210*210	660*420*210	\$30,40
GWM 15	230	50	30	300	2.800	0,20	0,90	1,01	10	121*205*235	605*410*235	\$33,50

TEKNİK ÇİZİM | TECHNICAL DRAWING

TEKNİK ÖLÇÜLER | TECHNICAL DIMENSIONS

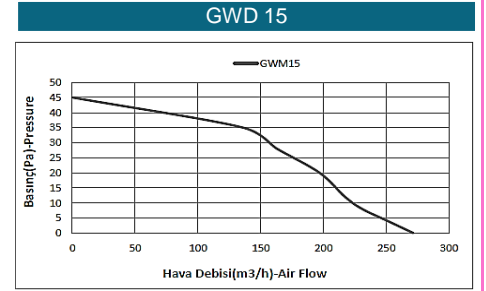
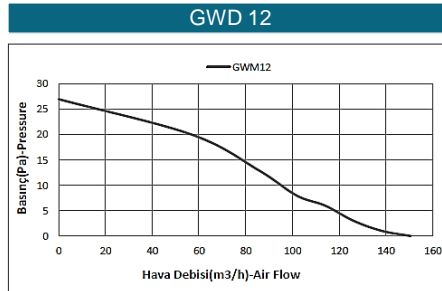
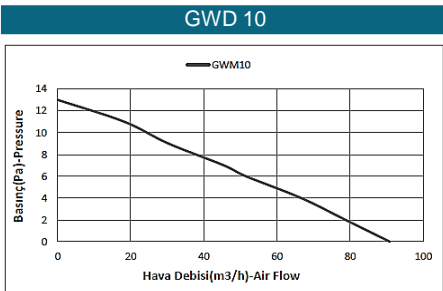
Tüm Ölçüler mm'dir. | All dimensions are in mm

Tip / Type	A	B	C	D
GWM 10	165	35	62,5	98
GWM 12	203	36	72,5	118
GWM 15	230*198	56	62,5	148

PERFORMANS VERİLERİ | PERFORMANCE DATA



GPJ DEKORATİF PANJURLU FANLAR

Decorative Shutter Fans

OPSIYONLAR:

- 110V - 60 Hz İndüksiyon Motoru
- Zaman Ayarı (1 - 60 dk. Arasında Ayarlanabilir)
- Hareket sensörü
- İpli Çalıştırma Sistemi
- SELV (12V AC)

OPTIONS

- 110V - 60 Hz Induction Motor
- Timer (Adjustable form 1 to 60 minutes)
- Motion Sensor
- Pull Cord
- SELV (12V AC)

TERMİK KORUMALI MOTOR

FAN VERİLERİ | DATA

Tip/Typ	Voltaj Voltage	Frekans	Güç Power	Debi Air Flow	Devir Speed	Akım Current	Ağırlık Weight Net	Ağırlık Weight Gross	Pieces Box	İç Kutu Ölç. Inner Box Size	Dış Kutu Ölç. Outer Box Size	Fiyat/Price
	V	Hz	Watt	m ³ /saat	R.p.m.	A	Kg	Kg	Ad.	mm	mm	Usd
GPJ 10	230	50	14	100	2.800	0,07	0,67	0,75	12	106*160*160	636*320*160	\$27,00
GPJ 12	230	50	25	170	2.800	0,14	0,81	0,92	12	120*185*185	720*370*185	\$30,00

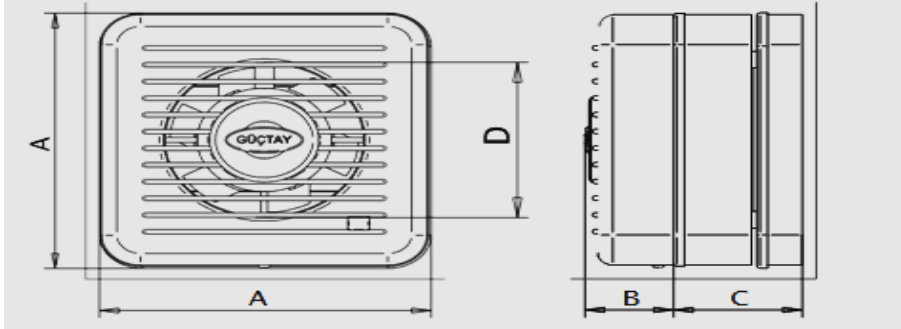
TEKNİK ÇİZİM | TECHNICAL DRAWING

TEKNİK ÖLÇÜLER | TECHNICAL DIMENSIONS

Tüm Ölçüler mm'dir. | All dimensions are in mm

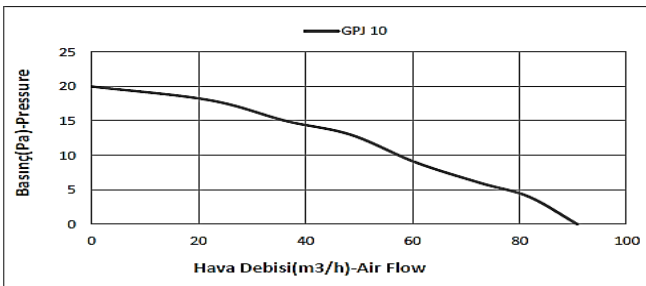
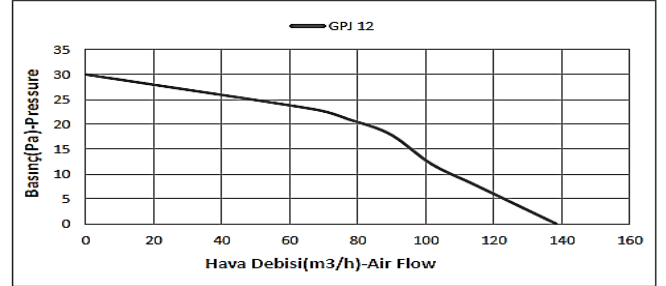
Tip / Type	A	B	C	D
GPJ 10	150	37	60	98
GPJ 12	180	47,50	64,00	118

PERFORMANS VERİLERİ | PERFORMANCE DATA
GPJ 10

GPJ 12



Wispy®



WPL15M OTOMATİK PANJURLU DEKORATİF FAN

Decorative Automatic Shutter Fan

- *Termal aktüatörle çalışan elektrikli iç kapakları olan otomatik aksiyel fanlardır.
- *Yavaşlatılmış sessiz kapak hareketi bulunmaktadır.
- *İki yönünde de panjur bulunmaktadır.

- Automatic axial fans provided with electrical internal shutters, operating via a thermal actuator,
- Delayed and silent shutter moving.
- There are blinds on both sides.

OPSİYONLAR:

- 110V - 60 Hz İndüksiyon Motoru
- Zaman Ayarı (1 - 60 dk. Arasında Ayarlanabilir)
- Hareket sensörü
- İpli Çalıştırma Sistemi
- SELV (12V AC)

OPTIONS

- 110V - 60 Hz Induction Motor
- Timer (Adjustable from 1 to 60 minutes)
- Motion Sensor
- Pull Cord
- SELV (12V AC)

TERMİK
KORUMALI
MOTOR



FAN VERİLERİ | DATA

Tip/Typ	Voltaj Voltage	Frekans	Güç Power	Debi Air Flow	Devir Speed	Akım Current	Ağırlık Weight Net	Ağırlık Weight Gross	Pieces Box	İç Kutu Ölç. Inner Box Size	Dış Kutu Ölç. Outer Box Size	Fiyat/Price
	V	Hz	Watt	m ³ /saat	R.p.m.	A	Kg	Kg	Ad.	mm	mm	Usd
WPL15M	230	50	30	300	2.650	0,18	1,31	1,42	10	142*205*235	710*410*235	\$41,00

TEKNİK ÇİZİM | TECHNICAL DRAWING

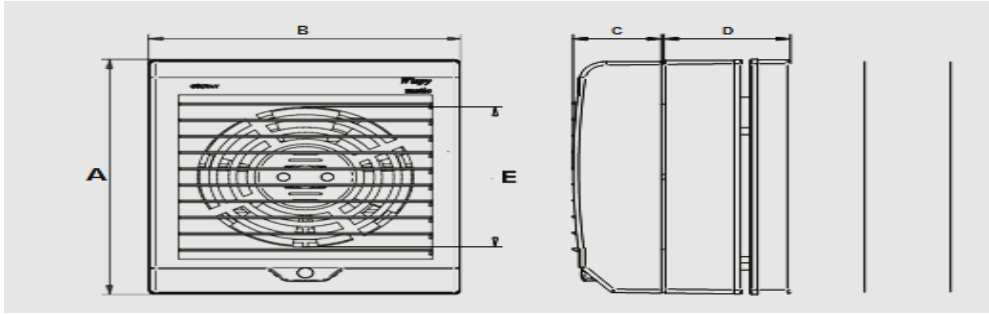

TEKNİK ÖLÇÜLER | TECHNICAL DIMENSIONS

Tüm Ölçüler mm'dir. | All dimensions are in mm

Tip / Type	A	B	C	D
WPL15M	198	56	79	148

PERFORMANS VERİLERİ | PERFORMANCE DATA

WPL15M

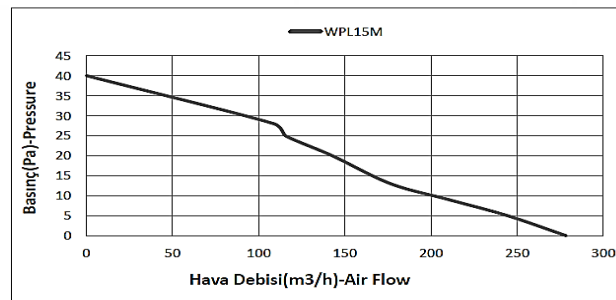



GPK PLASTİK KANAL FANLARI

In-line Plastic Duct Fans



*Havayı dışarıya doğrudan verecek ya da kısa bir boruya gönderecek şekilde tasarlanmıştır. (1.5 metreden daha kısa ve kıvrımsız)

*Düşük statik basınç karşısında, küçük ve orta hacimdeki hava hareketini sağlamaya yöneliktir.

*Meskenleri havalandırmak, aletleri soğutmak ya da kurutmak için tasarlanmıştır.

*Esnek veya sert borularla kullanılabilirler.

*Sıcak havanın en yakın odalara kanalizasyonu için duvarın üst kısmına yerleştirilir.

- Exhausts air directly outwards or into a short length ducting (shorter than 1,5 m and without curves)
- For moving small and medium air volumes against low static resistance.
- For ventilating domestic premises, cooling or drying appliances.
- Can be used with flexible or rigid ducting,
- For installation at the upper part of the wall for moving warm air into adjacent rooms,

OPSİYONLAR:

- İpli Çalıştırma Sistemi
- SELV (12V AC)

OPTIONS

- Pull Cord
- SELV (12V AC)

TERMİK
KORUMALI
MOTOR



FAN VERİLERİ | DATA

Tip/Typ	Voltaj Voltage	Frekans	Güç Power	Debi Air Flow	Devir Speed	Akım Current	Ağırlık Weight Net	Ağırlık Weight Gross	Pieces Box	İç Kutu Ölç. Inner Box Size	Dış Kutu Ölç. Outer Box Size	Fiyat/Price
	V	Hz	Watt	m ³ /saat	R.p.m.	A	Kg	Kg	Ad.	mm	mm	Usd
GPK 10	230	50	14	100	2.800	0,08	0,34	0,38	12	105*105*105	630*210*105	\$14,00
GPK 12	230	50	25	170	2.800	0,14	0,41	0,46	12	125*125*110	750*250*110	\$16,00
GPK 15	230	50	30	300	2.800	0,18	0,54	0,62	10	155*155*125	775*310*125	\$20,00

TEKNİK ÇİZİM | TECHNICAL DRAWING

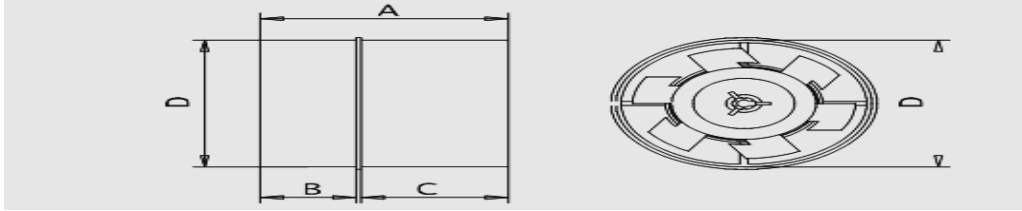

TEKNİK ÖLÇÜLER | TECHNICAL DIMENSIONS

Tüm Ölçüler mm'dir. | All dimensions are in mm

Tip / Type	A	B	C	D
GPK 10	150	20	77	98
GPK 12	170	23	74	118
GPK 15	210	25	72	148

PERFORMANS VERİLERİ | PERFORMANCE DATA

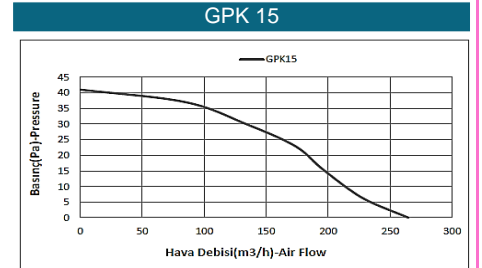
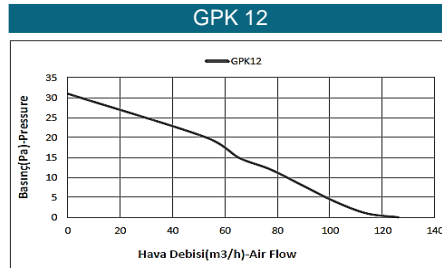
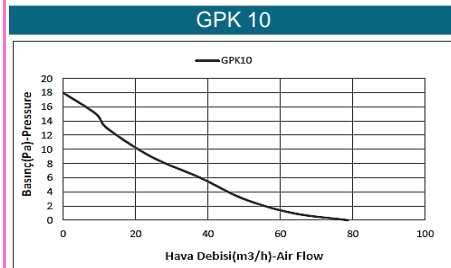



AKSİYAL KAPAKLI FANLAR

Axial Fans With Cover

GENEL AÇIKLAMA

Mutfaklarda, ofislerde, işyerlerinde vb. yerlerde kullanılabilirler. Ürün gövdesi metalden imal edilmiş olup, elektro statik toz boyalıdır. Pervanesi metalden imal edilmiş olup, elektro statik toz boyalıdır. Öndeki kapak sayesinde kullanılmadığında kapatılarak dış mekandan gelecek olan toz, rüzgar vb. şeyler engellenmiş olur. 220 V. 50 Hz. elektrikte çalışır. Motor ömrünün uzun olması ve motorun sessiz çalışmasını sağlayan, bakım gerektirmeyen kendini yağlayan küresel yatak bulunmaktadır. Kullanılabilir ölçüler: Ø 160 mm, Ø 200 mm, Ø 250 mm. Çalışma performansı yüksektir Enerji tasarrufu sağlayacak şekilde üretilmiştir. Sessiz ve uzun ömürlüdür. Fanlar EN 60335-2-80, EC Low Voltage Directive 73/23-93/68 ve EC Directive standartlarındadır. Maksimum 50°C de ortam havasını temizlemek için kullanılır.

GENERAL DESCRIPTION

Suitable for kitchens, offices, business etc. It can be mounted on windows, walls, ceilings, panels etc, the product body is made of metal and painted with electrostatic powder. Its fan is made of metal and painted with electrostatic powder. It operates at 220V. 50 Hz. Sleeve bearing motor, permanently lubricated for maintenance free operation and continuous running. Available sizes: Ø 160 mm, Ø 200 mm, Ø 250 mm. High operation performance. Designed to ensure energy saving. Noiseless and long life. Fans comply with EN 60335-2-80, EC Low Voltage Directive 73/23-93/68 and EC Directive EMC 89/336. They are designed for clean air with maximum temperature 50°C

OPSİYONLAR

- 110V, 60 Hz. Motor
- Ön ve Arka Izgara Koruma

OPTIONS

- 110V - 60 Hz Motor
- Front and Back Protection Grille

GK FAN VERİLERİ | DATA

Tip/Typ	Voltaj Voltage	Frekans	Güç Power	Debi Air Flow	Devir Speed	Akım Current	Ağırlık Weight Net	Ağırlık Weight Gross	Pieces Box	İç Kutu Ölç. Inner Box Size	Dış Kutu Ölç. Outer Box Size	Fiyat/Price
	V	Hz	Watt	m³/saat	R.p.m.	A	Kg	Kg	Ad.	mm	mm	Usd
GK 16	230	50	35	330	1.400	0,22	1,70	1,89	8	120*215*220	510*235*450	\$69,00
GK 20	230	50	40	680	1.400	0,23	1,96	2,21	10	140*265*265	725*275*545	\$74,00
GK 25	230	50	50	990	1.400	0,40	2,56	2,92	8	150*300*310	630*325*620	\$79,50

OPSIYONLAR/OPTIONS
• Ön ve Arka Izgara Koruma/ Front and Back Protection Grille

GK 16 CE	230	50	35	330	1.400	0,22	1,80	1,97	8	120*215*220	510*235*450	\$79,00
GK 20 CE	230	50	40	680	1.400	0,23	2,25	2,51	10	140*265*265	725*275*545	\$86,00
GK 25 CE	230	50	50	990	1.400	0,40	2,90	3,28	8	150*300*310	630*325*620	\$92,50

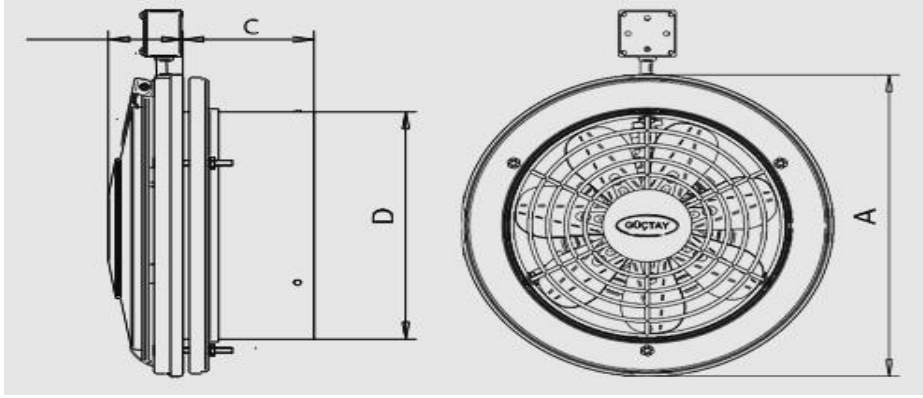
TEKNİK ÇİZİM | TECHNICAL DRAWING

TEKNİK ÖLÇÜLER | TECHNICAL DIMENSIONS

Tüm Ölçüler mm'dir. | All dimensions are in mm

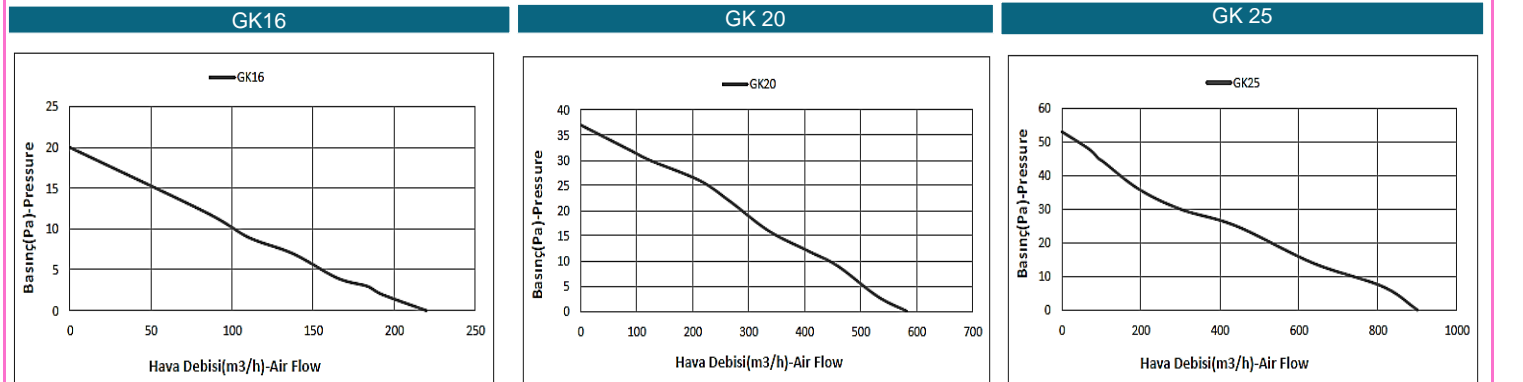
Tip / Type	A	B	C	D
GK 16	214	43	75	160
GK 20	260	46	70	200
GK 25	305	50	95	235

PERFORMANS VERİLERİ | PERFORMANCE DATA



AKSİYAL BACA-DUVAR FANLAR

Axial Wall Fans

GENEL AÇIKLAMA

Mutfaklarda, ofislerde, işyerlerinde vb. yerlerde kullanılabilirler. Duvar, tavan, panel vb. yerlere monte edilebilir. Ürün gövdesi metalden imal edilmiş olup, elektro statik toz boyalıdır. Pervanesi metalden imal edilmiş olup, elektro statik toz boyalıdır. 220 V. 50 Hz. elektrikte çalışır. Motor ömrünün uzun olması ve motorun sessiz çalışmasını sağlayan, bakım gerektirmeyen kendini yağlayan küresel yatak bulunmaktadır. Kullanılabilir ölçüler: Ø 160 mm, Ø 200 mm, Ø 250 mm, Ø 300 mm, Ø 350 mm. Çalışma performansı yüksektir. Enerji tasarrufu sağlayacak şekilde üretilmiştir. Sessiz ve uzun ömürlüdür. Fanlar EN 60335-2-80, EC Low Voltage Directive 73/23-93/68 ve EC Directive standartlarındadır. Maksimum 50°C de ortam havasını temizlemek için kullanılır.

GENERAL DESCRIPTION

Suitable for kitchens, offices, business etc. It can be mounted on windows, walls, ceilings, panels etc. The product body is made of metal and painted with electrostatic powder. Its fan is made of metal and painted with electrostatic powder. It operates at 220V. 50 Hz. Sleeve bearing motor, permanently lubricated for maintenance free operation and continuous running. Available sizes: Ø 160 mm, Ø 200 mm, Ø 250 mm. High operation performance. Designed to ensure energy saving. Noiseless and long life. Fans comply with EN 60335-2-80, EC Low Voltage Directive 73/23-93/68 and EC Directive EMC 89/336. They are designed for clean air with maximum temperature 50°C

OPSİYONLAR

- 110V, 60 Hz. Motor
- Ön ve Arka Izgara Koruma

OPTIONS

- 110V - 60 Hz Motor
- Front and Back Protection Grille

FAN VERİLERİ | DATA

Tip/Typ	Voltaj Voltage	Frekans	Güç Power	Debi Air Flow	Devir Speed	Akım Current	Ağırlık Weight Net	Ağırlık Weight Gross	Pieces Box	İç Kutu Ölç. Inner Box Size	Dış Kutu Ölç. Outer Box Size	Fiyat/Price
	V	Hz	Watt	m³/saat	R.p.m.	A	Kg	Kg	Ad.	mm	mm	Usd
GB 16	230	50	35	330	1.400	0,22	1,55	1,72	10	95*215*220	510*230*460	\$59,50
GB 20	230	50	40	400	1.400	0,23	1,66	1,89	10	115*270*265	620*280*550	\$67,00
GB 25	230	50	50	680	1.400	0,35	2,13	2,48	8	140*305*305	560*310*627	\$69,00
GB 30	230	50	50	785	1.400	0,35	2,39	2,76	8	125*372*375	380*525*770	\$74,00
GB 35	230	50	60	1250	1.400	0,45	2,82	3,37	5	135*425*430	705*440*440	\$77,00

OPSİYONLAR/OPTIONS
• Ön ve Arka Iızgara Koruma/ Front and Back Protection Grille

GB 16 CE	230	50	35	330	1.400	0,22	1,75	1,92	10	95*215*220	510*230*460	\$69,00
GB 20 CE	230	50	40	400	1.400	0,23	1,90	2,13	10	115*270*265	620*280*550	\$76,00
GB 25 CE	230	50	50	680	1.400	0,35	2,45	2,80	8	140*305*305	560*310*627	\$79,00
GB 30 CE	230	50	50	785	1.400	0,35	3,00	3,34	8	125*372*375	380*525*770	\$85,00
GB 35 CE	230	50	60	1250	1.400	0,45	2,82	3,37	5	135*425*430	705*440*440	\$88,00

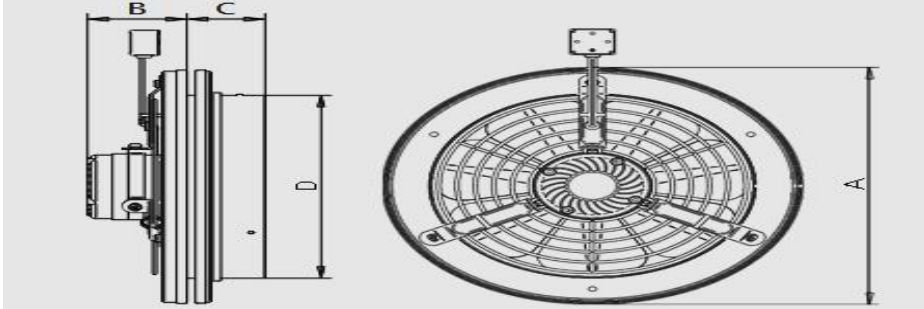
TEKNİK ÇİZİM | TECHNICAL DRAWING

TEKNİK ÖLÇÜLER | TECHNICAL DIMENSIONS

Tüm Ölçüler mm'dir. | All dimensions are in mm

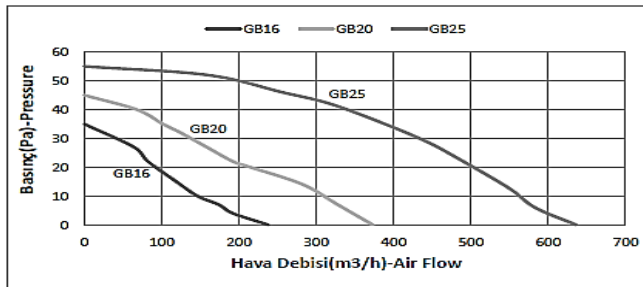
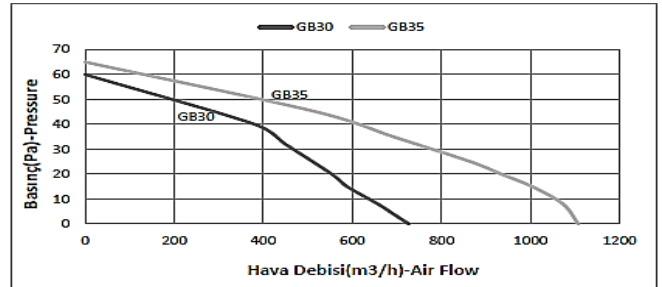
Tip / Type	A	B	C	D
GB 16	207	41	42	160
GB 20	256	66	40	200
GB 25	305	72	56	235
GB 30	372	53	54	315
GB 35	418	53	54	365

PERFORMANS VERİLERİ | PERFORMANCE DATA
GB16-20-25

GB30-35



AKSİYAL SANAYİ FANLARI

Axial Endustrial Fans

GENEL AÇIKLAMA

Duvar tipi fanlar; endüstriyel binaları, hayvan çiftlikleri, seralar, garajlar, spor salonları ve otopark gibi borusuz hava giriş çıkışı gerektiren yerlerin havalandırılması için tasarlanmıştır. Duvara ve pencereye monte edilebilir. Maksimum 60°C de ortam havasını temizlemek için kullanılır.

Gürültü düzeyinin düşük olmasının ve performansın yüksek olmasının nedeni giriş kısmındaki aerodinamik konik yapıdır.

Elektrostatik boyası sayesinde atmosfer parçacıklarına karşı korunur. Atmosfer parçacıklarına karşı çelik yatakta motor koruması.

Enerji tasarrufu sağlayacak şekilde üretilmiştir. Uluslararası IEC34-IEC72 ile 89/392 EEC-89-336 EEC-73/23 EEC standartlarına uygun ve B3/5, IP55 şeklinde CE işareti taşıyan, F sınıfı monofaze eşzamansız motorlar. IP55, F sınıfı S1 servisi (daimi yükte sürekli çalışma) Fanlar EN 60335-2-80, EC Low Voltage Directive 73/23-93/68 ve EC Directive standartlarındadır.

GENERAL DESCRIPTION

The fans of the wall are designed for ventilation of industrial buildings, stock farms, greenhouses, garages, gymnasiums, car parks, etc, in which are requested relevant air delivers without dueling. They are designed for clean air with maximum temperature 60°C. Reduce noise level and high efficiency are due to the aerodynamically shope inlet cone . Protected against atmospheric agentsby electrostatic paint.

Motor side protection guard in drawn steelrod protected against atmospheric agents. Designed to ensure energy saving. Single-phase asynchronous motor according To IEC34-IEC7Z and 89/392 EEC-89-336 EEC-73/23 EECstandarts, CE marked Form 83/5, IP55, class F, Service SI (continuous working at constantload). Fans comply with EN 60335-2-80, EC Low Voltage Directive 73/23-93/68 and EC Directive EMC 89/336,



GM-GT AKSİYAL SANAYİ FANLARI

Axial Industrial Fans

- Direkt akuple monofaze ve trifaze motor seçeneklerine sahiptir.
 - 6 kanatlı, içbükey kanat sistemi mevcuttur.
- It has direct coupled single-phase and three-phase motor options.
It has 6 bladed, concave blade system.

FAN VERİLERİ | DATA

Tip/Typ	Voltaj Voltage	Frekans	Güç Power	Debi Air Flow	Devir Speed	Akım Current	Ağırlık Weight Net	Ağırlık Weight Gross	Pieces Box	İç Kutu Ölç. Inner Box Size	Dış Kutu Ölç. Outer Box Size	Fiyat/Price
	V	Hz	Watt	m ³ /saat	R.p.m.	A	Kg	Kg	Ad.	mm	mm	Usd
GM 25	230	50	105	1.200	1.400	0,50	4,50	4,85	2	380*370*370		\$128,00
GM 30	230	50	110	1.700	1.400	0,50	5,50	5,85	2	380*370*370		\$136,00
GM 35	230	50	130	2.220	1.400	0,60	6,10	6,45	2	400*375*410		\$144,00
GM 40	230	50	210	3.450	1.400	0,91	7,40	7,90	2	488*382*475		\$152,00
GM 45	230	50	300	3.915	1.400	1,30	7,90	8,50	2	525*390*507		\$170,00
GM 50	230	50	220	4.780	1.400	1,00	10,10	10,70	2	400*570*575		\$181,00
GT 25	380	50	100	1.200	1.400	0,30	4,50	4,85	2	380*370*370		\$129,00
GT 30	380	50	105	1.700	1.400	0,30	5,60	5,90	2	380*370*370		\$137,00
GT 35	380	50	120	2.220	1.400	0,32	6,10	6,45	2	400*375*410		\$145,00
GT 40	380	50	200	3.450	1.400	0,52	7,30	7,70	2	490*380*475		\$152,00
GT 45	380	50	195	3.915	1.400	0,61	7,90	8,50	2	525*390*507		\$171,00
GT 50	380	50	205	4.780	1.400	0,61	10,20	10,80	2	400*570*575		\$183,00

TEKNİK ÇİZİM | TECHNICAL DRAWING

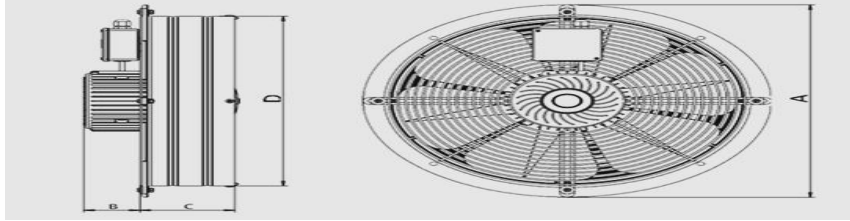

TEKNİK ÖLÇÜLER | TECHNICAL DIMENSIONS

Tüm Ölçüler mm'dir. | All dimensions are in mm

Tip / Type	A	B	C	D
GM/GT30	362	65	107	305
GM/GT35	410	65	107	350
GM/GT40	483	73	107	425
GM/GT50	575	85	122	515

PERFORMANS VERİLERİ | PERFORMANCE DATA

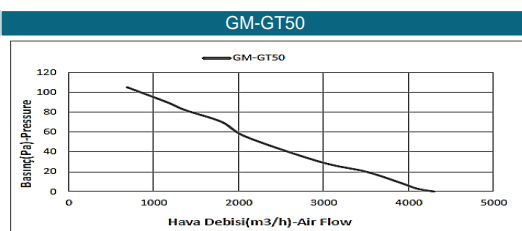
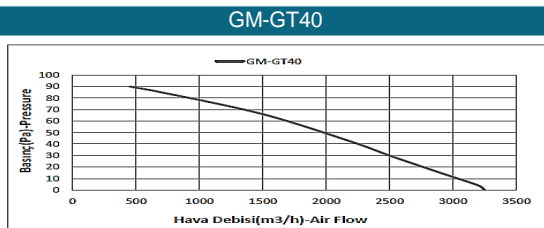
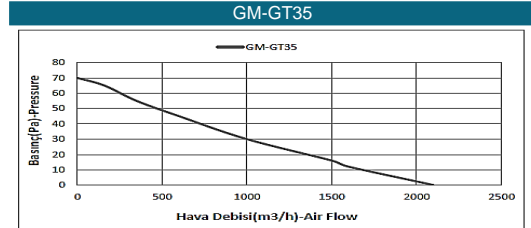
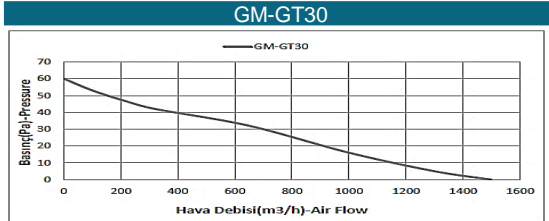



GSM-GST50



GSM-GST AKSİYAL SANAYİ FANLARI

Axial Industrial Fans Motor With Cooling Fans

- Direkt akuple monofaze ve trifaze motor seçeneklerine sahiptir.
- Ürün motorları soğutma fanıdır.
- 60 çaplı üründe 5 kanatlı pervane sistemi mevcuttur.

It has direct coupled single-phase and three-phase motor options.

The product motors have cooling fans.

There is a 5-bladed propeller system in the 60-diameter product.



GSM-GST 60

FAN VERİLERİ | DATA

Tip/Typ	Voltaj Voltage	Frekans	Güç Power	Debi Air Flow	Devir Speed	Akım Current	Ağırlık Weight Net	Ağırlık Weight Gross	Pieces Box	İç Kutu Ölç. Inner Box Size	Dış Kutu Ölç. Outer Box Size	Fiyat/Price
	V	Hz	Watt	m³/saat	R.p.m.	A	Kg	Kg	Ad.	mm	mm	Usd
GSM 50	230	50	240	4.780	1.400	1,05	10,50	11,20	1		280*620*550	\$202,00
GSM 60	230	50	350	8.000	1.400	1,28	11,30	12,50	1		250*670*680	\$218,00
GST 50	380	50	235	4.780	1.400	0,61	10,50	11,2	1		280*620*550	\$203,00
GST 60	380	50	340	8.000	1.400	0,92	11,30	12,50	1		270*680*380	\$220,00

TEKNİK ÇİZİM | TECHNICAL DRAWING

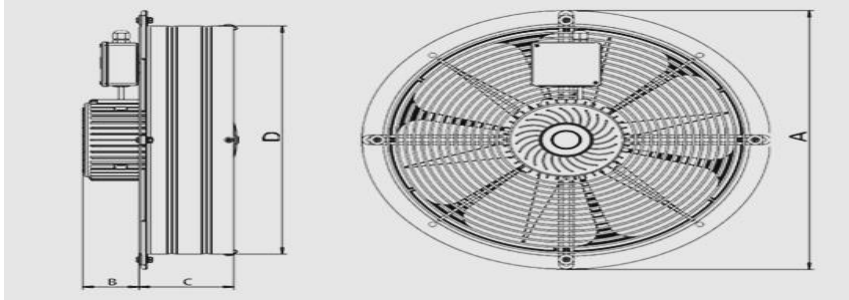

TEKNİK ÖLÇÜLER | TECHNICAL DIMENSIONS

Tüm Ölçüler mm'dir. | All dimensions are in mm

Tip / Type	A	B	C	D
GSM/GST50	575	110	122	517
GSM/GST60	660	110	142	602

PERFORMANS VERİLERİ | PERFORMANCE DATA

GSM-GST50

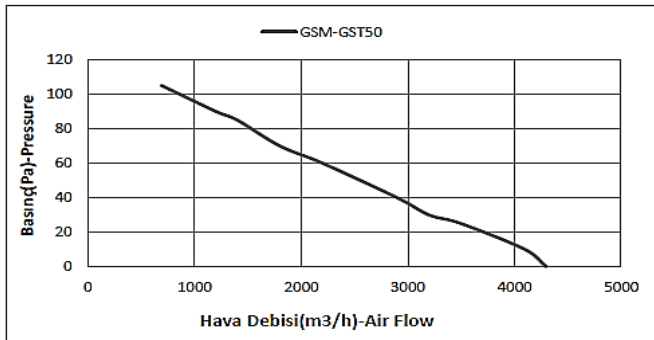

GSM-GST60

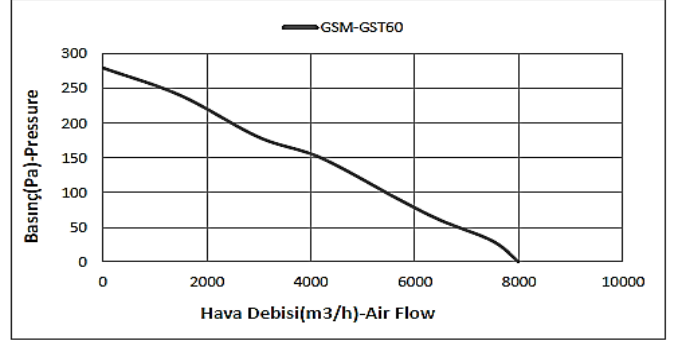

GMK-GTK AKSİYAL KARE TİP SANAYİ FANLARI

Square Type Axial Industrial Fans

- Direkt akuple monofaze ve trifaze motor seçeneklerine sahiptir.
- 6 kanatlı, içbükey kanat sistemi mevcuttur.

It has direct coupled single-phase and three-phase motor options.

It has 6 bladed, concave blade system.

FAN VERİLERİ | DATA

Tip/Typ	Voltaj Voltage	Frekans	Güç Power	Debi Air Flow	Devir Speed	Akım Current	Ağırlık Weight Net	Ağırlık Weight Gross	Pieces Box	İç Kutu Ölç. Inner Box Size	Dış Kutu Ölç. Outer Box Size	Fiyat/Price
	V	Hz	Watt	m ³ /saat	R.p.m.	A	Kg	Kg	Ad.	mm	mm	Usd
GMK 25	230	50	105	1.200	1.400	0,50	5,30	5,90	2	400*375*410		\$144,00
GMK 30	230	50	110	1.700	1.400	0,50	6,30	6,90	2	400*375*410		\$154,00
GMK 35	230	50	130	2.220	1.400	0,60	6,90	7,50	2	490*380*475		\$163,00
GMK 40	230	50	210	3.450	1.400	0,91	8,50	9,2	2	400*570*575		\$168,00
GMK 45	230	50	215	4.600	1.400	0,91	9,50	10,2	2	400*570*575		\$185,00
GMK 50	230	50	220	4.780	1.400	1,00	11,70	12,60	1	250*670*630		\$205,00
GSMK 60	230	50	350	8.000	1.400	1,28	13,30	14,50	1	250*670*680		\$252,00
GTK 25	380	50	100	1.200	1.400	0,30	5,30	5,90	2	400*375*410		\$145,00
GTK 30	380	50	105	1.700	1.400	0,30	6,40	7,00	2	400*375*410		\$155,00
GTK 35	380	50	120	2.220	1.400	0,32	6,90	7,50	2	490*380*475		\$164,00
GTK 40	380	50	200	3.450	1.400	0,52	8,50	9,20	2	400*570*575		\$169,00
GTK 45	380	50	195	4600	1.400	0,61	10,70	11,60	2	222*602*602		\$186,00
GTK 50	380	50	205	4.780	1.400	0,61	11,70	12,60	1	250*670*630		\$206,00
GSTK 60	380	50	340	8.000	1.400	0,92	13,30	14,50	1	250*670*680		\$254,00

TEKNİK ÇİZİM | TECHNICAL DRAWING

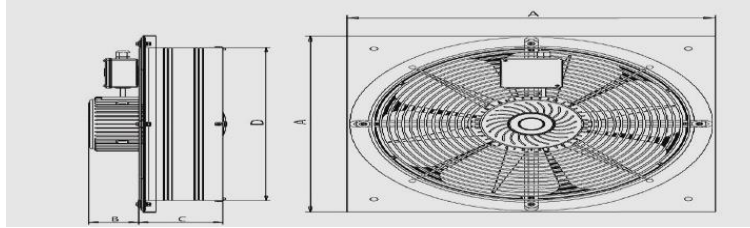

TEKNİK ÖLÇÜLER | TECHNICAL DIMENSIONS

Tüm Ölçüler mm'dir. | All dimensions are in mm

Tip / Type	A	B	C	D
GMK/GTK30	362	65	107	305
GMK/GTK35	410	65	107	350
GMK/GTK40	483	73	107	425
GMK/GTK50	575	85	122	515
GSMK/GSTK60	660	85	140	602

PERFORMANS VERİLERİ | PERFORMANCE DATA

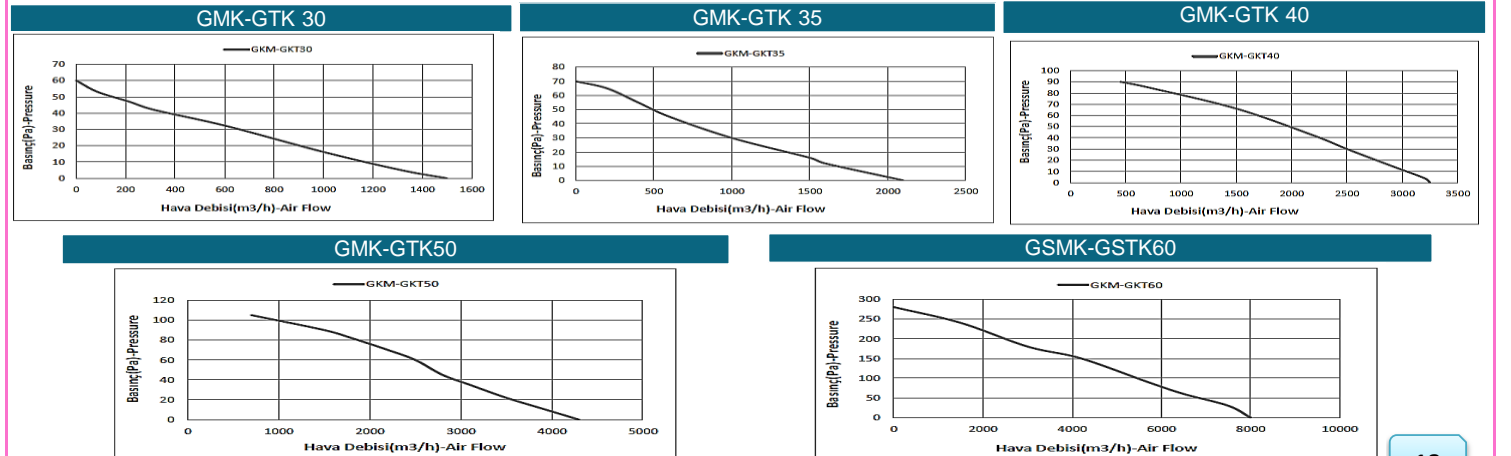



GBS AKSİYAL SANAYİ FANLARI (HP MOTORLU)

Axial Industrial Fans With HP Motors

OPSİYONLAR:

- Exproof Motorlu

OPTIONS:

With exproof motor

FAN VERİLERİ | DATA

Tip/Typ	Voltaj Voltage	Frekans	Güç Power	Debi Air Flow	Devir Speed	Akım Current	Ağırlık Weight Net	Ağırlık Weight Gross	Pieces Box	İç Kutu Ölç. Inner Box Size	Dış Kutu Ölç. Outer Box Size	Fiyat/Price
	V	Hz	Kw	m ³ /saat	R.p.m.	A	Kg	Kg	Ad.	mm	mm	Usd
GBS 40	380	50	0,25	3.500	1.450	1,00	9,70	10,70	1		490*380*475	\$410,00
GBS 45	380	50	0,37	4.200	1.450	1,20	10,50	11,50	1		620*280*549	\$500,00
GBS 50	380	50	0,37	5.500	1.450	1,20	12,20	13,40	1		620*280*550	\$540,00
GBS 60	380	50	0,55	9.000	1.450	2,00	17,60	18,8	1		630*325*620	\$640,00
GBS 70	380	50	1,1	14.000	1.450	2,70	30,80	31,30	1		800*800*450	\$900,00
GBS 80	380	50	2,2	25.500	1.450	5,30	44,50	45,50	1		830*830*520	\$1.075,00

* Monofaze Ürünler için fiyat alınız.

TEKNİK ÇİZİM | TECHNICAL DRAWING

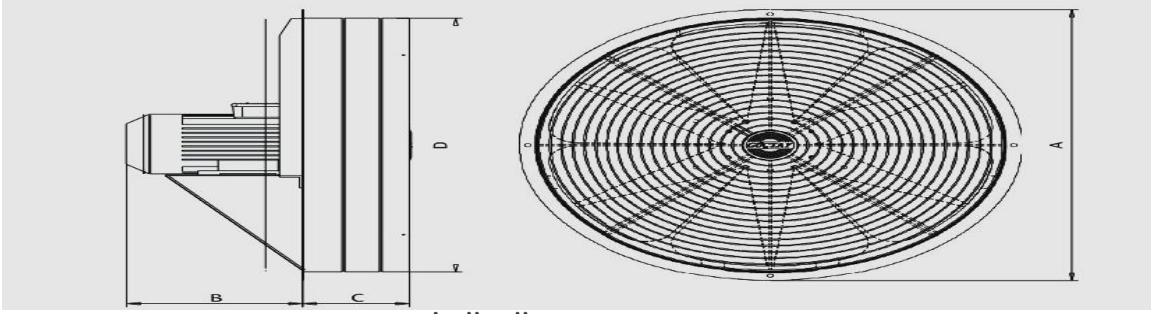

TEKNİK ÖLÇÜLER | TECHNICAL DIMENSIONS

Tüm Ölçüler mm'dir. | All dimensions are in mm

Tip / Type	A	B	C	D
GBS40	483	150	107	425
GBS50	575	150	122	515
GBS60	660	200	150	600
GBS70	770	250	175	720
GBS80	890	305	185	830

PERFORMANS VERİLERİ | PERFORMANCE DATA

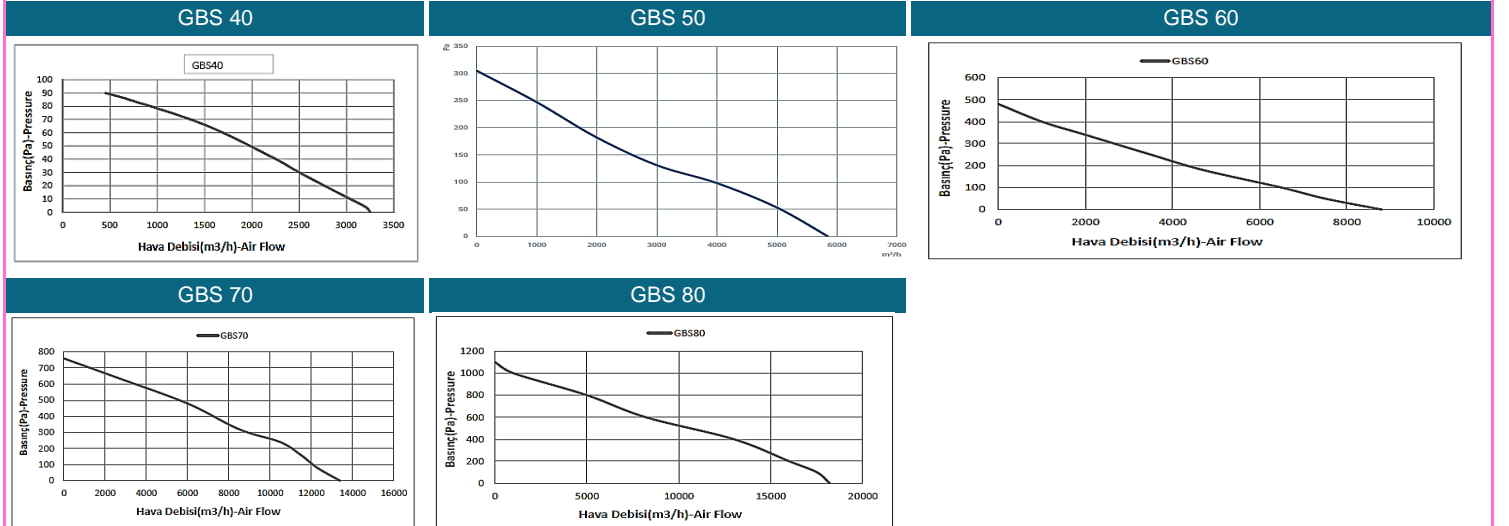



GBSK AKSİYAL KARE KASALI PLASTİK PERVANELİ FANLAR

Axial Plastic Propeller Square Fans With HP Motors

OPSIYONLAR:

- Alüminyum pervane
- Exproof Motorlu

OPTIONS:

- With Aluminum propeller
- With exproof motor

FAN VERİLERİ | DATA

Tip/Typ	Voltaj Voltage	Frekans	Güç Power	Debi Air Flow	Devir Speed	Ağırlık Weight Net	Pieces Box	Fiyat/Price
	V	Hz	Kw	m ³ /saat	R.p.m.	Kg	Ad.	Usd
GBSK 400-5-25	380	50	0,37	2.890	1.450	18,10	1	\$600,00
GBSK 450-5-25	380	50	0,55	4.180	1.450	30,00	1	\$675,00
GBSK 500-5-25	380	50	0,55	5.840	1.450	35,00	1	\$750,00
GBSK 560-5-25	380	50	0,75	8.150	1.450	42,00	1	\$825,00
GBSK 630-5-30	380	50	1,1	13.480	1.450	47,00	1	\$950,00
GBSK 710-5-30	380	50	1,5	19.200	1.450	55,00	1	\$1.100,00
GBSK 800-5-30	380	50	2,2	25.550	1.450	68,50	1	\$1.400,00
GBSK 800-5-35	380	50	3	30.940	1.450	70,00	1	\$1.650,00
GBSK 900-5-35	380	50	4	39.250	1.450	82,00	1	\$1.700,00
GBSK 900-5-40	380	50	5,5	44.635	1.450	90,00	1	\$2.000,00
GBSK1000-5-40	380	50	7,5	54.550	1.450	120,00	1	\$2.300,00

***HP MOTORLU

TEKNİK ÇİZİM | TECHNICAL DRAWING

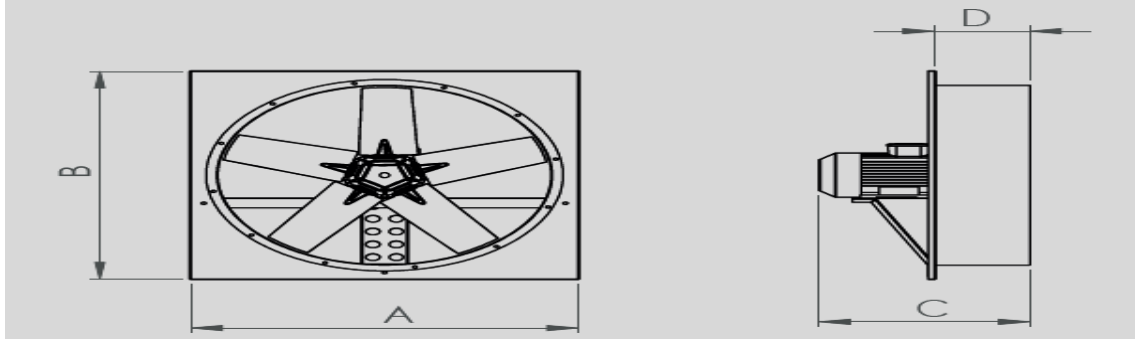

TEKNİK ÖLÇÜLER | TECHNICAL DIMENSIONS

Tüm Ölçüler mm'dir. | All dimensions are in mm

Tip / Type	A	B	C	D
GBSK 400	570	570	400	200
GBSK 450	610	610	410	200
GBSK 500	650	650	410	200
GBSK 560	680	680	410	200
GBSK 630	750	750	420	200
GBSK 710	830	830	450	200
GBSK 800	920	920	480	200
GBSK 900	1020	1020	590	300
GBSK 1000	1120	1120	700	300

PERFORMANS VERİLERİ | PERFORMANCE DATA

GBSK 400-5-25

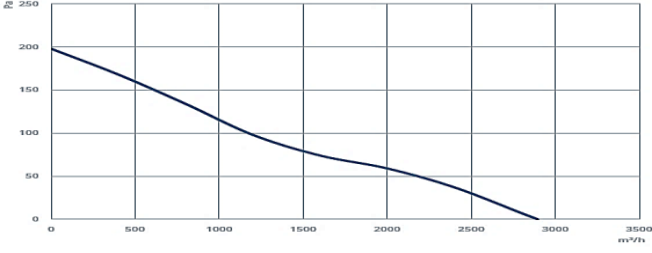

GBSK 450-5-25

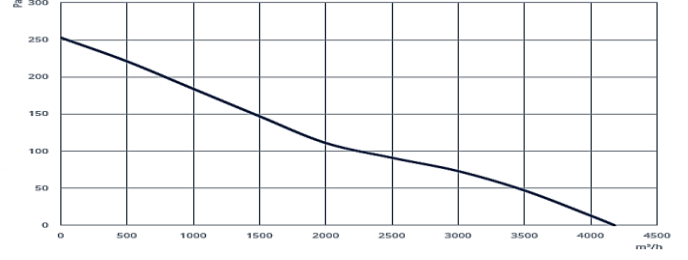

GBSK 500-5-25

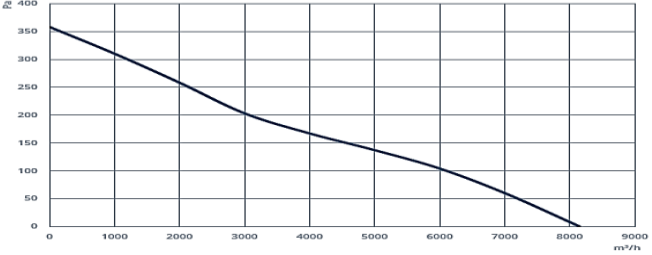

GBSK 560-5-25

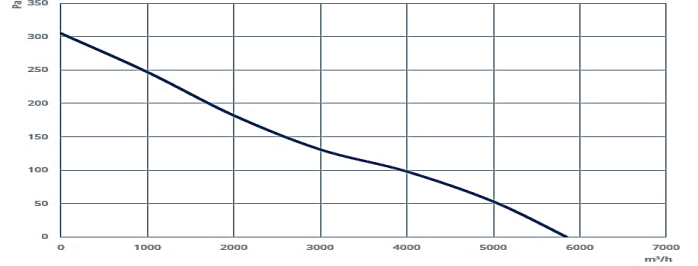

GBSK 630-5-30

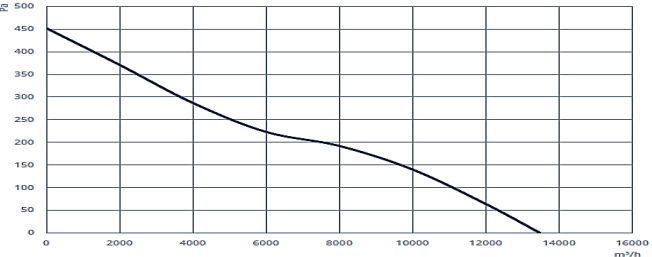

GBSK 710-5-30

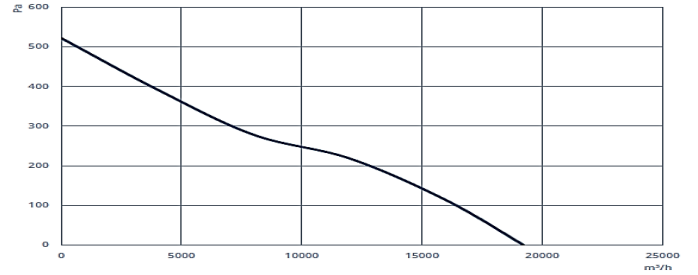

GBSK 800-5-30

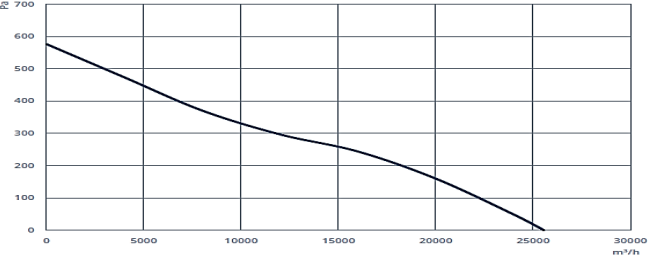

GBSK 800-5-35

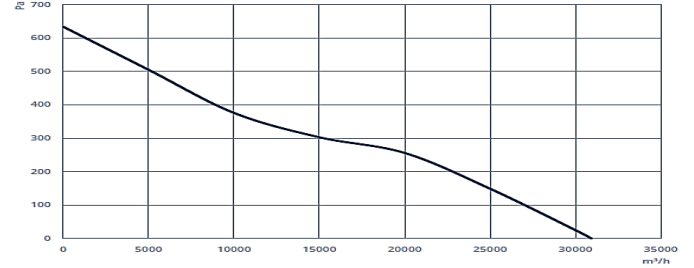

GBSK 900-5-35

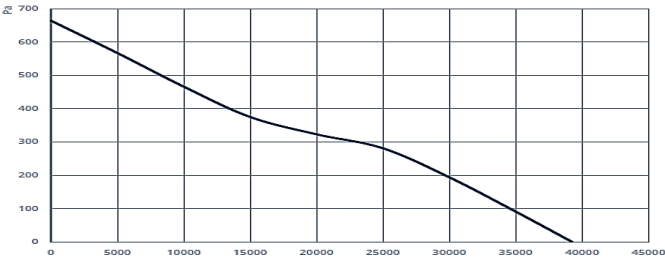

GBSK 900-5-40

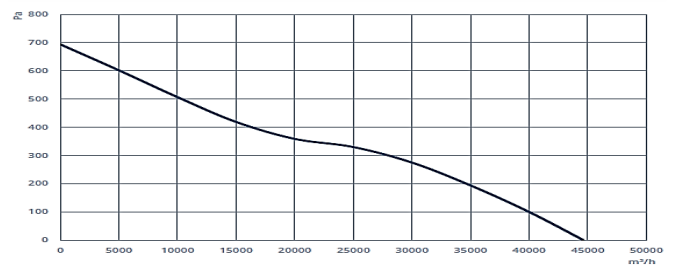

GBSK1000-5-40

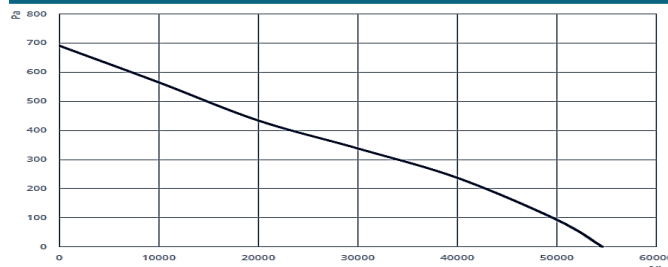



GSOF AKSİYAL SOĞUTMA FANLARI (DIŞTAN ROTORLU MOTOR)

External Motor Axial Wall Type Fans

Soğutma fanları, ticari ve endüstriyel buzdolapları ile soğuk odalarda bataryaya hava üflemek için kullanılır. Üfleyci veya emici şeklinde üretilebilir.

Cooling fans are used to blow air into the battery in commercial and industrial refrigerators and cold rooms. It can be produced as a blower or a suck

FAN VERİLERİ | DATA

Tip/Typ	Voltaj Voltage	Frekans	Güç Power	Debi Air Flow	Devir Speed	Ağırlık Weight Net	Ağırlık Weight Gross	Pieces Box	Fiyat/Price	
	V	Hz	Watt	m³/saat	R.p.m.	Kg	Kg	Ad.	Usd	
GSOF 250	220	50	50	1.000	1.350	4,30	4,60	1	\$106,00	
GSOF 300	220	50	90	1.700	1.350	4,90	5,30	1	\$116,00	
GSOF 350	220	50	138	2.980	1.350	5,77	6,20	1	\$200,00	
GSOF 400	220	50	180	3.900	1.350	6,60	7,00	1	\$216,00	
GSOF 450	220	50	250	5.100	1.350	7,91	8,40	1	\$250,00	
GSOF 500	220/380	50	470	6.900	1.350	8,40	9,00	1	\$410,00	
GSOF 630	220/380	50	900	12.300	1.350	9,50	10,00	1	\$525,00	

TEKNİK ÇİZİM | TECHNICAL DRAWING

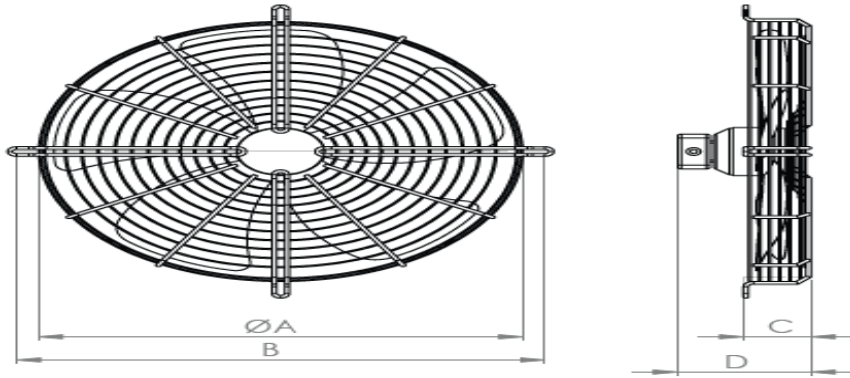

TEKNİK ÖLÇÜLER | TECHNICAL DIMENSIONS

Tüm Ölçüler mm'dir. | All dimensions are in mm

Tip / Type	A	B	C	D
GSOF 250	250	330	80	130
GSOF 300	300	380	80	130
GSOF 350	350	430	80	130
GSOF 400	400	480	100	150
GSOF 450	450	530	100	150
GSOF 500	525	565	90	170
GSOF 630	680	745	95	200

GDY AKSİYAL DUVAR TİPİ YUVARLAK FANLAR
(DIŞTAN ROTORLU MOTOR)



External Motor Axial Wall Type Fans

FAN VERİLERİ | DATA

Tip/Typ	Voltaj Voltage	Frekans	Güç Power	Debi Air Flow	Devir Speed	Akım Current	Ağırlık Weight Net	Ağırlık Weight Gross	Pieces Box	İç Kutu Ölç. Inner Box Size	Dış Kutu Ölç. Outer Box Size	Fiyat/Price
	V	Hz	Watt	m³/saat	R.p.m.	A	Kg	Kg	Ad.	mm	mm	Usd
GDY 200	230	50	70	1.200	2.650	0,40	2,20	2,50	1		310*310*140	\$79,00
GDY 250	230	50	100	1.800	2.700	0,44	3,20	3,50	1		330*330*170	\$89,00
GDY 300	230	50	170	2.900	2.550	0,96	3,60	4,10	1		430*430*190	\$100,00
GDY 350	230	50	200	4.500	2.400	0,86	4,30	4,80	1		430*430*190	\$115,00

TEKNİK ÇİZİM | TECHNICAL DRAWING

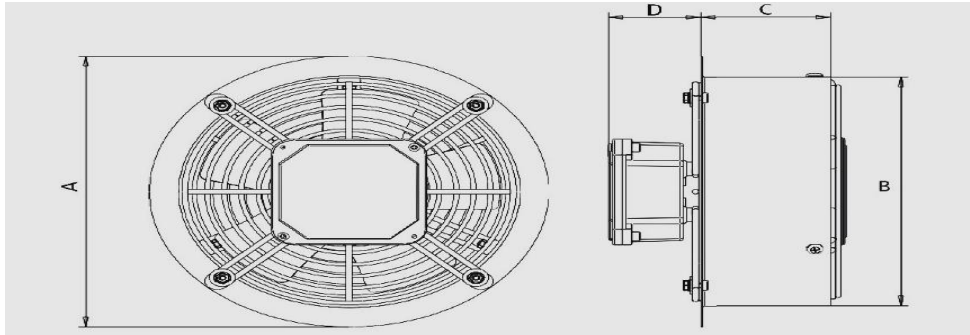

TEKNİK ÖLÇÜLER | TECHNICAL DIMENSIONS

Tüm Ölçüler mm'dir. | All dimensions are in mm

Tip / Type	A	B	C	D
GDY200	260	200	55	90
GDY250	310	250	55	90
GDY300	360	300	55	90
GDY350	410	350	55	90
GDY400	460	400	55	90

PERFORMANS VERİLERİ | PERFORMANCE DATA

GDY200-250-300

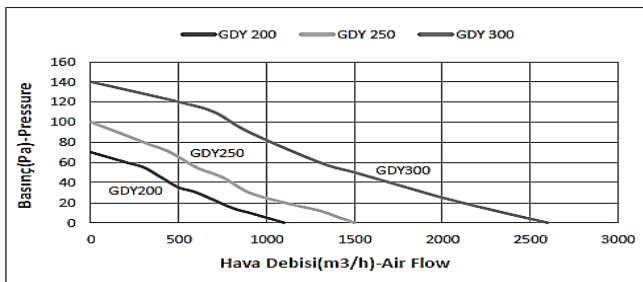

GDY350-400

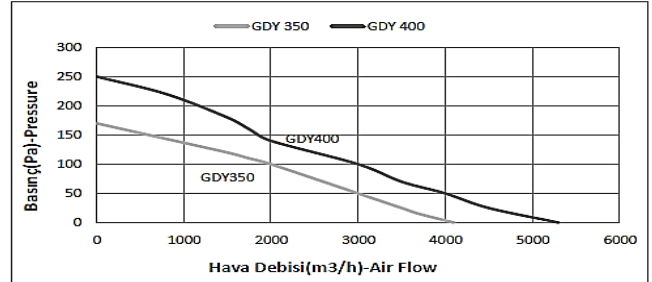



GDK AKSİYAL DUVAR TİPİ KARE FANLAR (DIŞTAN ROTORLU MOTOR)

External Motor Axial Wall Type Square Fans

FAN VERİLERİ | DATA

Tip/Typ	Voltaj Voltage	Frekans	Güç Power	Debi Air Flow	Devir Speed	Akım Current	Ağırlık Weight Net	Ağırlık Weight Gross	Pieces Box	İç Kutu Ölç. Inner Box Size	Dış Kutu Ölç. Outer Box Size	Fiyat/Price
	V	Hz	Watt	m³/saat	R.p.m.	A	Kg	Kg	Ad.	mm	mm	Usd
GDK 200	230	50	70	1.200	2.650	0,40	2,70	3,00	1		310*310*140	\$89,00
GDK 250	230	50	100	1.800	2.700	0,44	3,30	3,60	1		340*335*140	\$99,00
GDK 300	230	50	170	2.900	2.550	0,96	4,20	4,80	1		430*430*190	\$115,00
GDK 350	230	50	200	4.500	2.400	0,86	5,10	5,70	1		430*430*190	\$125,00

TEKNİK ÇİZİM | TECHNICAL DRAWING

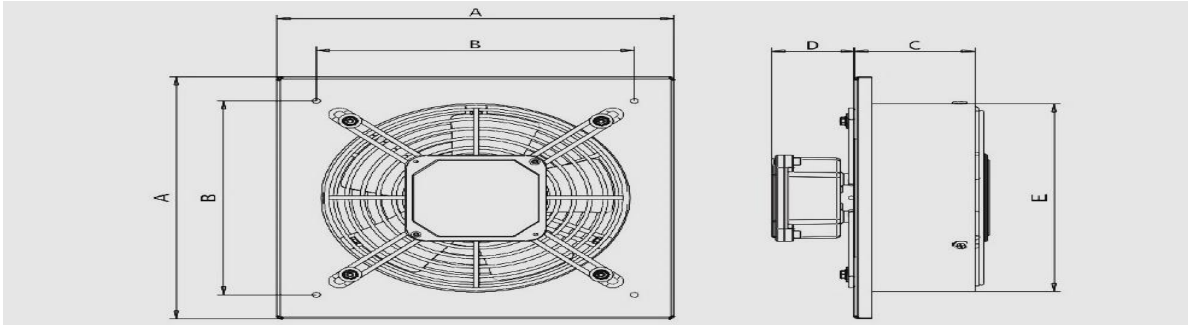

TEKNİK ÖLÇÜLER | TECHNICAL DIMENSIONS

Tüm Ölçüler mm'dir. | All dimensions are in mm

Tip / Type	A	B	C	D	E
GDK200	260	190	55	90	200
GDK250	310	240	55	90	250
GDK300	360	290	55	90	300
GDK350	410	340	55	90	350

PERFORMANS VERİLERİ | PERFORMANCE DATA

GDK200-250-300

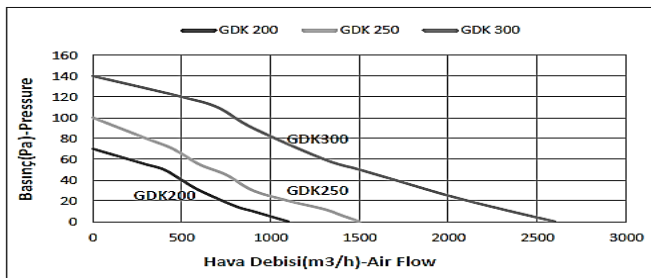

GDK350-400

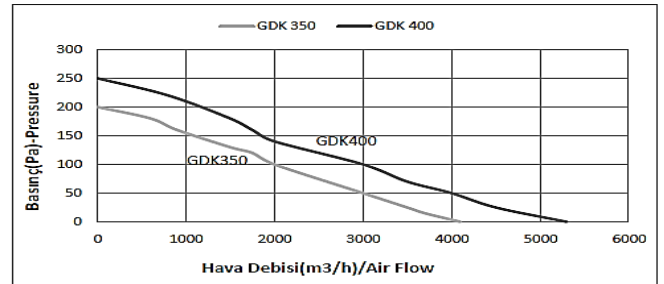



GKF AKSİYAL BORU TİPİ FANLAR
(DIŞTAN ROTORLU MOTOR)
External Motor Axial Duct Type Fans

FAN VERİLERİ | DATA

Tip/Typ	Voltaj Voltage	Frekans	Güç Power	Debi Air Flow	Devir Speed	Akım Current	Ağırlık Weight Net	Ağırlık Weight Gross	Pieces Box	İç Kutu Ölç. Inner Box Size	Dış Kutu Ölç. Outer Box Size	Fiyat/Price
	V	Hz	Watt	m³/saat	R.p.m.	A	Kg	Kg	Ad.	mm	mm	Usd
GKF 200	230	50	70	1.200	2.650	0,40	2,30	2,50	1		265*222*212	\$84,00
GKF 250	230	50	100	1.800	2.700	0,44	2,50	2,80	1		300*250*212	\$94,00
GKF 300	230	50	170	2.900	2.550	0,96	3,70	4,10	1		380*380*270	\$105,00
GKF 350	230	50	200	4.500	2.400	0,86	4,50	5,00	1		430*430*270	\$120,00

TEKNİK ÇİZİM | TECHNICAL DRAWING

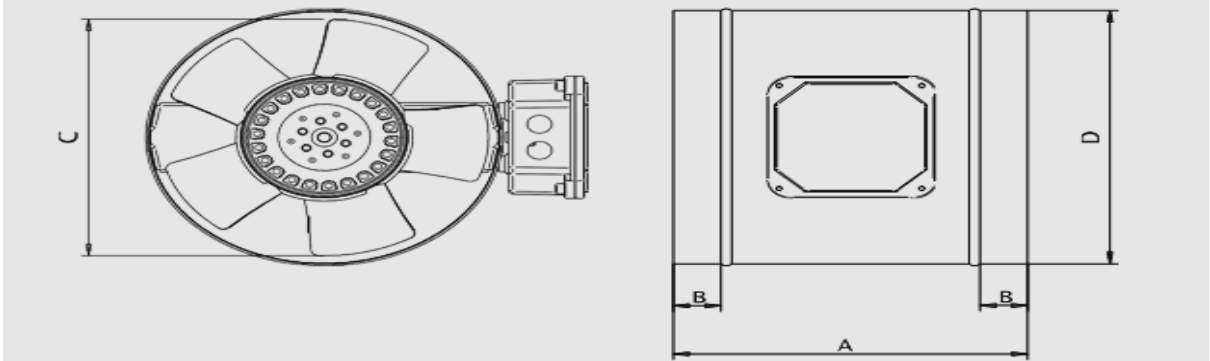

TEKNİK ÖLÇÜLER | TECHNICAL DIMENSIONS

Tüm Ölçüler mm'dir. | All dimensions are in mm

Tip / Type	A	B	C	D
GKF200	200	30	185	200
GKF250	200	30	235	250
GKF300	250	40	285	300
GKF350	250	40	335	350
GKF400	300	45	385	400

PERFORMANS VERİLERİ | PERFORMANCE DATA

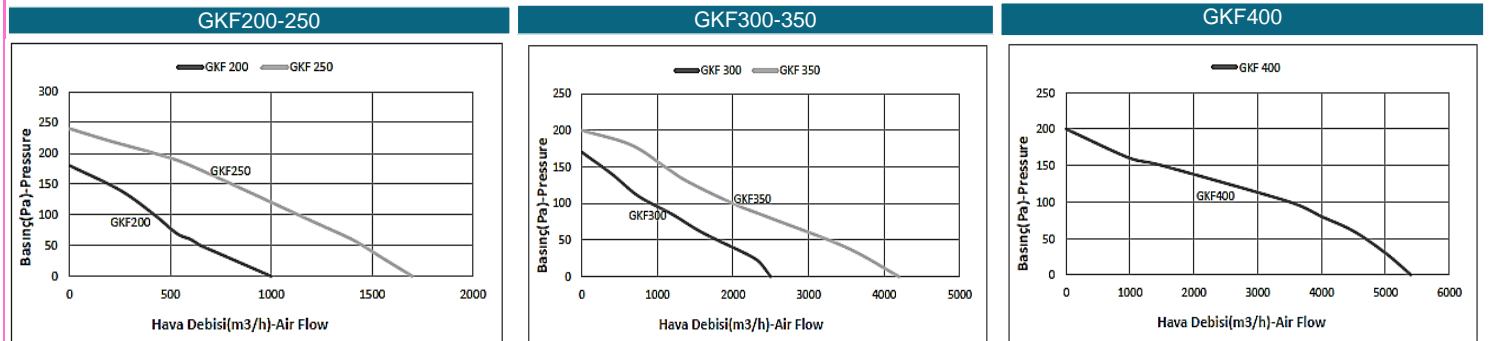



GBF AKSİYAL BASINÇLANDIRMA FANLARI

Axial Pressure Fans

- Aksiyal basınçlandırma fanları; merdiven, asansör boşluğu gibi basınçlandırma ihtiyacı olan yerlerde kullanılır.
- Kanallı sistemlerde yüksek debi ihtiyacı olan projelerde tercih edilebilir.

Axial pressurization fans; It is used in places that need pressurization such as stairs and elevator shafts. It can be preferred in projects that require high flow in ducted systems.

OPSIYONLAR:

- İstenilen renkte elektrostatik toz boya
- İstenilen debi ve basınçta özel üretim
- 5-8-12-16 Kanat adedi seçenekleri
- Alüminyum veya plastik kanat seçeneği

OPTIONS:

- Electrostatic powder paint in desired color
- Special production at desired flow and pressure
- 5-8-12-16 blade number options
- Aluminum or plastic blade option



Koruma teli ve ayak hariçtir

FAN VERİLERİ | DATA

*Değerler 0 Pa içindir

Tip/Typ	Voltaj Voltage	Frekans	Güç Power	Debi Air Flow	Devir Speed	Ağırlık Weight Net	Pieces Box	Fiyat/Price
	V	Hz	Kw	m ³ /saat	R.p.m.	Kg	Ad.	Usd
GBF400-5-25	380	50	0,37	2.900	1.450	19,00	1	\$585,00
GBF450-5-25	380	50	0,55	4.150	1.455	23,00	1	\$650,00
GBF500-5-25	380	50	0,55	5.800	1.450	26,00	1	\$665,00
GBF560-5-25	380	50	0,75	8.150	1.465	29,00	1	\$800,00
GBF630-5-30	380	50	1,1	13.450	1.465	44,50	1	\$900,00
GBF710-5-30	380	50	1,5	19.200	1.470	63,50	1	\$1.070,00
GBF800-5-30	380	50	2,2	25.550	1.460	63,00	1	\$1.270,00
GBF800-5-35	380	50	3	30.900	1.470	70,00	1	\$1.400,00
GBF900-5-35	380	50	4	39.250	1.470	89,00	1	\$1.640,00
GBF900-5-40	380	50	5,5	44.600	1.475	96,50	1	\$1.950,00
GBF1000-5-40	380	50	7,5	54.550	1.450	110,00	1	\$2.250,00
GBF900-8-40	380	50	11	46.200	1.455	140,00	1	\$3.195,00
GBF1000-8-40	380	50	15	62.250	1.455		1	\$3.650,00
GBF1000-8-45	380	50	18,5	69.000	1.470		1	\$4.250,00
GBF1120-8-40	380	50	22	86.600	1.470		1	\$5.350,00
GBF1120-8-45	380	50	30	95.250	1.470		1	\$5.995,00

TEKNİK ÇİZİM | TECHNICAL DRAWING

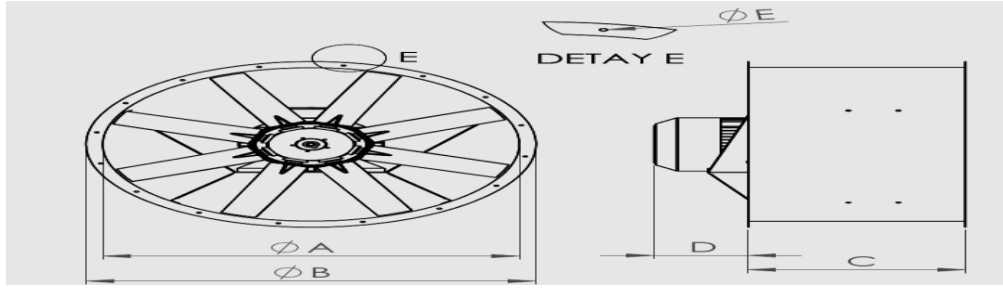

TEKNİK ÖLÇÜLER | TECHNICAL DIMENSIONS

Tüm Ölçüler mm'dir. | All dimensions are in mm

Tip / Type	A	B	C	D	E	DELİK SAYISI
GBF400-5-25	400	480	320	30	11	8
GBF450-5-25	450	530	320	50	11	8
GBF500-5-25	500	580	320	70	11	8
GBF560-5-25	560	640	320	60	11	12
GBF630-5-30	630	710	420	45	11	12
GBF710-5-30	710	790	420	25	11	12
GBF800-5-30	800	880	420	50	11	16
GBF800-5-35	800	880	420	50	11	16
GBF900-5-35	900	980	520	0	11	16
GBF900-5-40	900	980	520	35	11	16
GBF1000-5-40	1000	1080	520	150	11	16
GBF900-8-40	900	980	520	75	11	16
GBF1000-8-40	1000	1080	520	180	11	16
GBF1000-8-45	1000	1080	520	250	11	16
GBF1120-8-40	1120	1200	520	250	11	16
GBF1120-8-45	1120	1200	520	300	11	16



GDEF AKSİYAL DUMAN EGZOZ FANLARI

Axial Smoke Exhaust Fans

- Aksiyal duman egzoz fanları **300** derece sıcaklığa 2 saat boyunca dayanır.
- Duman tahliyesi için kullanılır.
Axial smoke exhaust fans withstand temperatures of **300** degrees for 2 hours.
It is used for smoke evacuation.

OPSİYONLAR:

- İstenilen debi ve basınçta özel üretim
- 5-8-12-16 Kanat adedi seçenekleri

OPTIONS:

- Special production at desired flow and pressure
- 5-8-12-16 blade number options

Koruma teli ve avak harictir

FAN VERİLERİ | DATA

*Değerler 0 Pa içindir

Tip/Typ	Voltaj Voltage	Frekans	Güç Power	Debi Air Flow	Devir Speed	Ağırlık Weight Net	Ağırlık Weight Gross	Pieces Box	Fiyat/Price	
	V	Hz	Kw	m³/saat	R.p.m.	Kg	Kg	Ad.	Usd	
GDEF450-5-25	380	50	0,55	4.150	1.455	33,00		1	\$975,00	
GDEF500-5-25	380	50	0,55	5.800	1.450	35,00		1	\$985,00	
GDEF560-5-25	380	50	0,75	8.150	1.465	45,00		1	\$1.160,00	
GDEF630-5-30	380	50	1,1	13.450	1.465	50,00		1	\$1.300,00	
GDEF710-5-30	380	50	1,5	19.200	1.470	59,00		1	\$1.490,00	
GDEF800-5-30	380	50	2,2	25.550	1.460	69,00		1	\$1.795,00	
GDEF800-5-35	380	50	3	30.900	1.470	76,00		1	\$1.890,00	
GDEF900-5-35	380	50	4	39.250	1.470	90,00		1	\$2.020,00	
GDEF900-5-40	380	50	5,5	44.600	1.475	100,00		1	\$2.781,00	
GDEF1000-5-40	380	50	7,5	54.550	1.450	121,00		1	\$3.173,00	
GDEF900-8-40	380	50	11	46.200	1.455	180,00		1	\$4.687,00	
GDEF1000-8-40	380	50	15	62.250	1.455	240,00		1	\$5.287,00	
GDEF1000-8-45	380	50	18,5	69.000	1.470			1	\$5.984,00	
GDEF1120-8-40	380	50	22	86.600	1.470			1	\$6.395,00	
GDEF1120-8-45	380	50	30	95.250	1.470			1	\$8.200,00	

TEKNİK ÇİZİM | TECHNICAL DRAWING

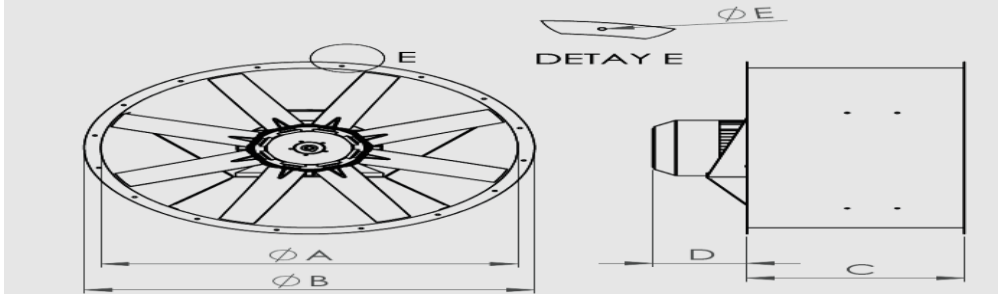

TEKNİK ÖLÇÜLER | TECHNICAL DIMENSIONS

Tüm Ölçüler mm'dir. | All dimensions are in mm

Tip / Type	A	B	C	D	E	DELİK SAYISI
GDEF450-5-25	450	530	320	50	11	8
GDEF500-5-25	500	580	320	70	11	8
GDEF560-5-25	560	640	320	60	11	12
GDEF630-5-30	630	710	420	45	11	12
GDEF710-5-30	710	790	420	25	11	12
GDEF800-5-30	800	880	420	50	11	16
GDEF800-5-35	800	880	420	50	11	16
GDEF900-5-35	900	980	520	0	11	16
GDEF900-5-40	900	980	520	35	11	16
GDEF1000-5-40	1000	1080	520	150	11	16
GDEF900-8-40	900	980	520	75	11	16
GDEF1000-8-40	1000	1080	520	180	11	16
GDEF1000-8-45	1000	1080	520	250	11	16
GDEF1120-8-40	1120	1200	520	250	11	16
GDEF1120-8-45	1120	1200	520	300	11	16



AKSİYAL SERA VE HAYVANCILIK FANLARI

Axial Greenhouse And Livstock Fans

GENEL AÇIKLAMA

Güçtay havalandırma fan gövdeleri ve kanatları galvanizli sacdan üretilmektedir. Kanat yapıları, kuvveti ve verimliliği artırmak için özel olarak dizayn edilmiştir. Motor yapısı ve gücü, daha düşük enerji tüketimi ve sessiz çalışma ortamı sağlamaktadır. Panjurlu fanlarda panjur, fan çalışırken açılır, fan durduğunda kapanır. Fanlar, havalandırma sorunu olan tüm kapalı alanlarda kullanılabilir. Özellikle seralarda bitkiler için gerekli olan iklimlendirmenin sağlanmasında; kümes hayvanları çiftlikleri, ahırlar gibi yerlerde havanın homojen olarak dağıtılmasında; fabrika, atölye vb. yerlerde oluşan tozun, dumanın, kötü kokuların dışarı atılmasında kullanılmaktadır. Bitki seralarında kullanılacak sirkülasyon fanları, kod olarak; iklimlendirme için kurulan sistemin üstünde konumlandırılmalı; su, buhar, sisleme vb sistemin çıkışı uçlarından en az 3 mt. uzak olmalıdır. İklimlendirme koşullarına uygunluğu, iklimlendirme sistemine doğru adaptasyonu, alıcının sorumluluğu altındadır. Uygulama kaynaklı arızalar garanti kapsamı dışındadır. Uygulama esnasında ürünlere, motor koruma şalteri ve kaçak akım rölesi takılması enerji akım dengesinin sağlanması için zorunludur. Bu eksik nedeniyle oluşan arızalar garanti kapsamı dışındadır.

GENERAL DESCRIPTION

The main bodies and wings of Güçtay ventilation fans are made of galvanized steel sheet. The propeller is specially designed to increase the power and efficiency. The motor design and power provide a lower energy consumption and silent running. In louvered fans, the louver opens when the fan is running, and closes when the fan stops. Fans can be used in all closed areas with ventilation problems. Especially in providing the necessary air-conditioning for plants in greenhouses; It is used in the homogeneous distribution of air in places such as poultry farms, barns, factories, workshops, etc.

It is used to remove dust, smoke and bad odors formed in places. Circulation fans used in plant greenhouses should be placed on top of the system installed for air conditioning and should be at least 3 meters away from the outlet ends of water, steam, fogging, etc. systems. The buyer is responsible for the compliance of the circulation fans to be used in plant greenhouses with the air conditioning conditions and their correct adaptation to the air conditioning system. Malfunctions caused by the application are not covered by the warranty. In order to ensure the balance of energy current during application, it is mandatory to install a motor protection switch and a residual current relay on the products. Malfunctions caused by this deficiency are not covered by the warranty.



GSF AKSİYAL SERA SİRKÜLASYON FANLARI

Axial Greenhouse Circulation Fans

OPSIYONLAR:
• Monofaze Motorlu

OPTIONS:
With single-phase motor



*Askı aparatları ürünün ekidir

FAN VERİLERİ | DATA

Tip/Typ	Voltaj Voltage	Frekans	Güç Power	Debi Air Flow	Devir Speed	Akım Current	Ağırlık Weight Net	Ağırlık Weight Gross	Pieces Box	İç Kutu Ölç. Inner Box Size	Dış Kutu Ölç. Outer Box Size	Fiyat/Price
	V	Hz	W/Kw	m³/saat	R.p.m.	A	Kg	Kg	Ad.	mm	mm	Usd
GSFT 350	380	50	160	4.100	1.400	0,60	10,00	11,00	1		410*410*270	Fiyat Sorunuz
GSFT 400	380	50	180	5.890	1.400	0,91	11,70	13,00	1		520*495*505	Fiyat Sorunuz
GSFT 460	380	50	370	7.400	1.400	1,00	12,40	13,70	1		520*495*505	Fiyat Sorunuz
GSFT 600	380	50	370	8.900	1.400	1,00	16,70	18,40	1		640*630*505	Fiyat Sorunuz
**GÜÇTAY MOTOR												
GSF400 HP	380	50	0,18	5.890	1.400		12,00	13,00	1		520*495*505	Fiyat Sorunuz
GSF460 HP	380	50	0,25	7.400	1.400		13,10	14,50	1		520*495*505	Fiyat Sorunuz
GSF600 HP	380	50	0,37	8.900	1.400		18,80	20,50	1		640*630*505	Fiyat Sorunuz

**** HP MOTOR**

TEKNİK ÇİZİM | TECHNICAL DRAWING

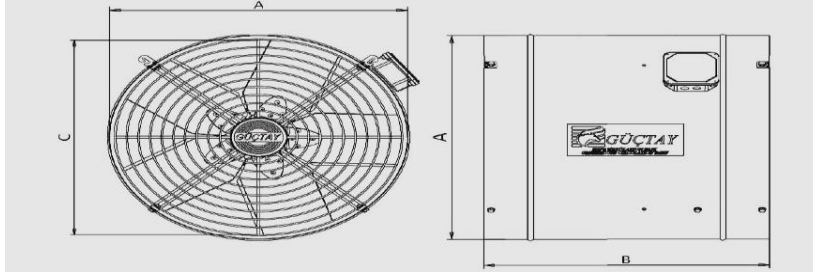

TEKNİK ÖLÇÜLER | TECHNICAL DIMENSIONS

Tüm Ölçüler mm'dir. | All dimensions are in mm

Tip / Type	A	B	C
GSF 350	360	490	340
GSF 400	410	490	390
GSF 460	480	490	460
GSF 600	610	490	590

PERFORMANS VERİLERİ | PERFORMANCE DATA

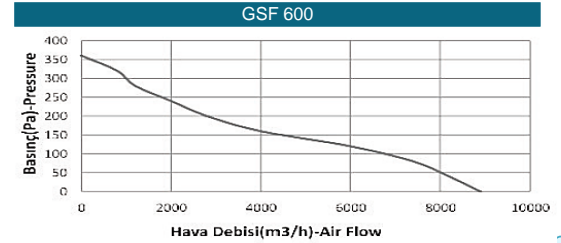
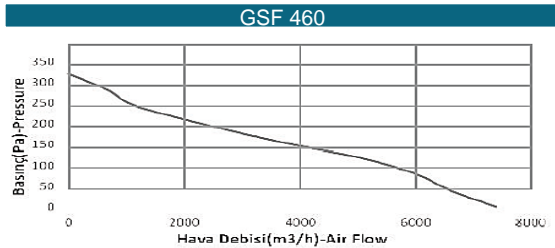
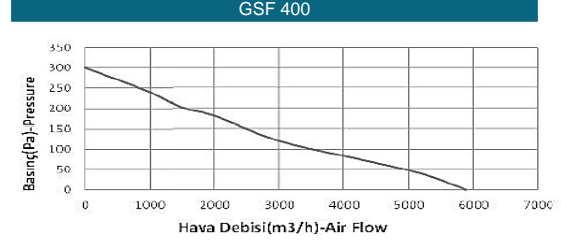
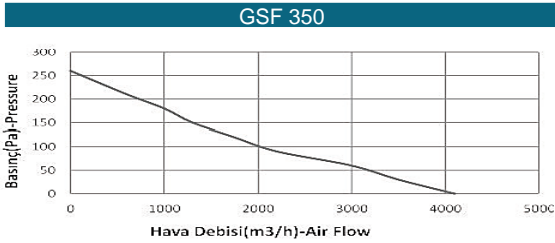



GHF AKSİYAL PANJURLU HAVALANDIRMA FANLARI

Axial Ventilation Fans



OPSIYONLAR:

- Monofaze Motorlu
- Paslanmaz kanat
- Hız kontrol cihazı uygulama
- Tekerlekli sehpa takma

OPTIONS:

- With single-phase motor
- Stainless steel impeller
- Speed Controller
- Wheel mounting

FAN VERİLERİ | DATA

Tip/Typ	Voltaj Voltage	Frekans	Güç Power	Debi Air Flow	Devir Speed	Akım Current	Ağırlık Weight Net	Ağırlık Weight Gross	Pieces Box	İç Kutu Ölç. Inner Box Size	Dış Kutu Ölç. Outer Box Size	Fiyat/Price
	V	Hz	Kw	m³/saat	R.p.m.	A	Kg	Kg	Ad.	mm	mm	Usd
GHF 60	380	50	0,37	7.000	1.400	1,20	25,00	25,50	1		601*601*304	\$660,00
GHF 80	380	50	0,55	9.000	1.400	2,00	36,00	37,00	1		810*810*400	\$750,00
GHF 100	380	50	0,55	20.000	1.400	2,00	49,00	50,00	1		1002*1002*457	\$790,00
GHF 140	380	50	1,1	44.000	1.400	2,00	79,00	80,00	1		1401*1401*457	\$945,00

**GHF60-80 DİREKT AKUPLE, GHF100-140 KAYIŞ KASNAKLI

TEKNİK ÇİZİM | TECHNICAL DRAWING

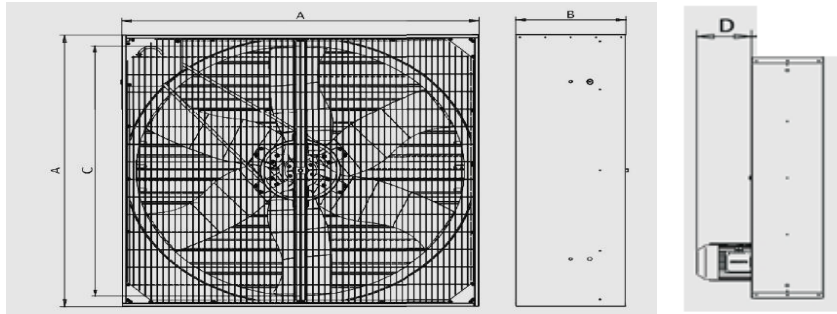

TEKNİK ÖLÇÜLER | TECHNICAL DIMENSIONS

Tüm Ölçüler mm'dir. | All dimensions are in mm

Tip / Type	A	B	A	D
GHF 60	600	300	600	130
GHF 80	806	394	806	130
GHF 100	1000	450	1000	0
GHF 140	1400	450	1400	0

PERFORMANS VERİLERİ | PERFORMANCE DATA

GHF 60-80

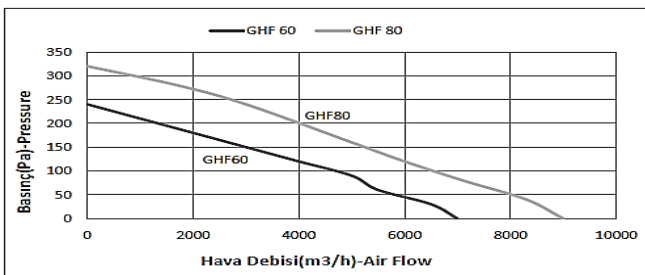

GHF 100-140

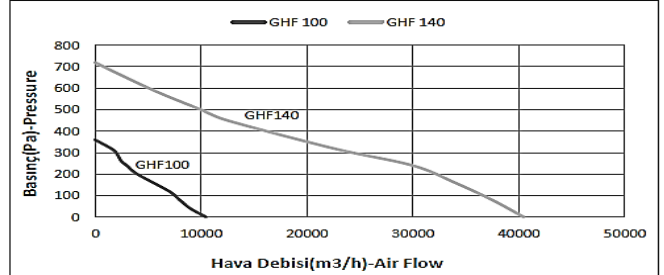

GHF AKSİYAL TEL+TEL HAVALANDIRMA FANLARI
Axial Dairy Ventilation Fans
OPSİYONLAR:

- Monofaze Motorlu
- Hız kontrol cihazı uygulama
- Tekerlekli sehpa takma

OPTIONS:

- With single-phase motor
- Speed Controller
- Wheel mounting

FAN VERİLERİ | DATA

Tip/Typ	Voltaj Voltage	Frekans	Güç Power	Debi Air Flow	Devir Speed	Akım Current	Ağırlık Weight Net	Ağırlık Weight Gross	Pieces Box	İç Kutu Ölç. Inner Box Size	Dış Kutu Ölç. Outer Box Size	Fiyat/Price
	V	Hz	Kw	m ³ /saat	R.p.m.	A	Kg	Kg	Ad.	mm	mm	Usd
GHF 60 TT	380	50	0,37	7.000	1.400	1,20	22,00	22,50	1		601*601*304	\$650,00
GHF 80 TT	380	50	0,55	9.000	1.400	2,00	33,00	34,00	1		810*810*400	\$740,00
GHF 100 TT	380	50	0,55	20.000	1.400	2,00	45,00	46,00	1		1002*1002*457	\$780,00
GHF 140TT	380	50	1,1	44.000	1.400	2,00	75,00	76,00	1		1401*1401*457	\$935,00

****GHF60-80 DİREKT AKUPLE, GHF100-140 KAYIŞ KASNAKLI**

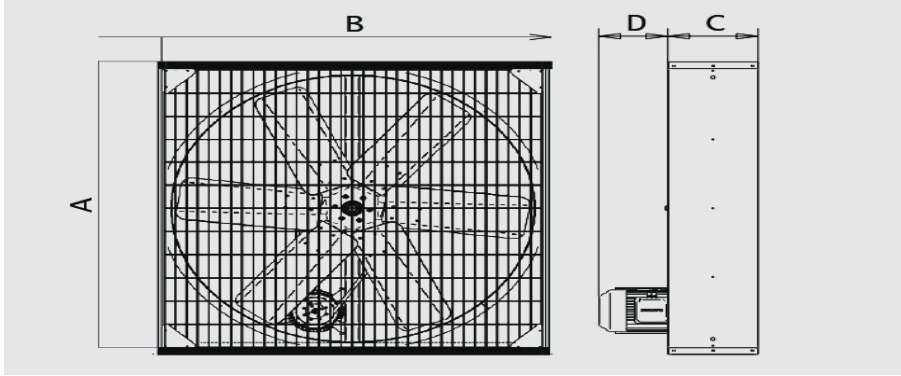
TEKNİK ÇİZİM | TECHNICAL DRAWING

TEKNİK ÖLÇÜLER | TECHNICAL DIMENSIONS

Tüm Ölçüler mm'dir. | All dimensions are in mm

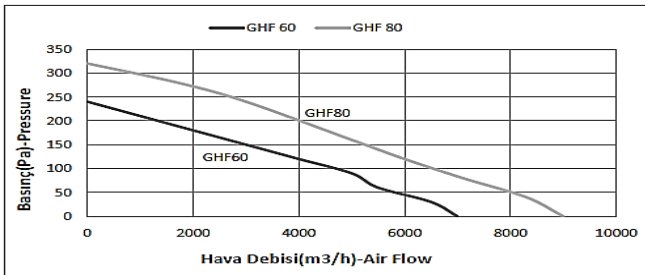
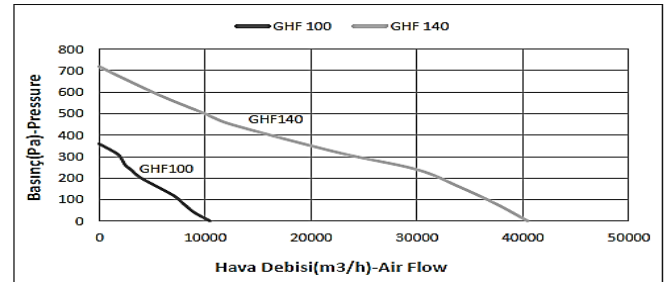
Tip / Type	A	B	C	D
GHF 60	600		300	600
GHF 80	806		394	806
GHF 100	1000		450	1000
GHF 140	1400		450	1400

PERFORMANS VERİLERİ | PERFORMANCE DATA
GHF 60-80

GHF 100-140



VANTİLATÖRLER

Ventilators



GENEL AÇIKLAMA

- Açık alan, fabrika, atölye, salon, hol ve benzeri yerleri serinletme amaçlıdır.
- Maksimum 60°C de ortam havasını temizlemek için kullanılır.
- % 100 Bakır sargılı motor
- Motor gövdesi alüminyumdan imal
- Aşırı ısınmaya karşı korumalı motor.
- Yeni görünüm, yüksek hava debisi, düşük ses düzeyi
- Elektronik hız kontrol anahtarı
- Metal ayaklar,
- Alüminyum pervane

GENERAL DESCRIPTION

- Suitable for cooling -temperature in factories, workshop, warehouse and hall etc.
- They are designed for clean air with maximum temperature 60°
- With 100 % real copper motor
- Motor body with aluminium material
- Full cooling temperature system, motor with long service life & energy - saving
- Novel outlook, large air volume, temperature rising & low noise
- Three speeds;
- Steel or plastic base
- Aluminium propeller





GAV AYAKLI VE DUVAR VANTİLATÖRLERİ

Stand and Wall Ventilators



*Hız kontrol devreli

FAN VERİLERİ | DATA

Tip/Typ	Voltaj Voltage	Frekans	Güç Power	Debi Air Flow	Devir Speed	Akım Current	Ağırlık Weight Net	Ağırlık Weight Gross	Pieces Box	İç Kutu Ölç. Inner Box Size	Dış Kutu Ölç. Outer Box Size	Fiyat/Price
	V	Hz	Kw	m³/saat	R.p.m.	A	Kg	Kg	Ad.	mm	mm	Usd
GAV 600A	230	50	225	11.000	1.400	0,90	18,00	19,00	1		260*750*750	\$288,00
GAV 750A	230	50	250	17500	1.400	1,20	20,00	21,00	1		280*860*840	\$307,00
GAV 600D	230	50	225	11.000	1.400	0,90	18,00	19,00	1		260*750*750	\$278,00
GAV 750D	230	50	250	17.500	1.400	1,20	20,00	21,00	1		280*860*840	\$288,00

TEKNİK ÇİZİM | TECHNICAL DRAWING

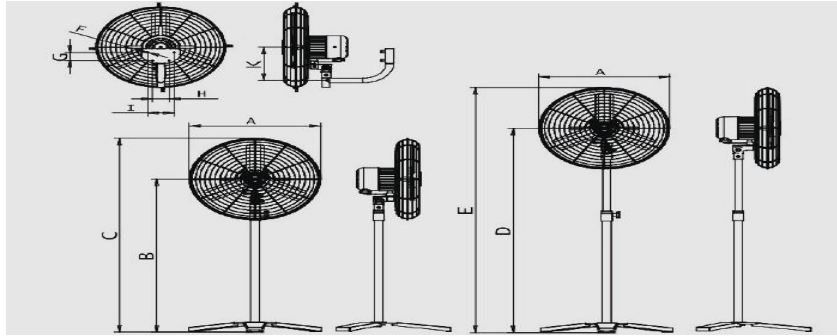

TEKNİK ÖLÇÜLER | TECHNICAL DIMENSIONS

Tüm Ölçüler mm'dir. | All dimensions are in mm

Tip / Type	A	B	C	D	D	F	G	H	I	K
GAV 600A	670	1055	1390	1460	1745					
GAV 750A	820	1055	1465	1535	1820					
GAV 600D	670					8,50	58	73	114	280
GAV 750D	820					8,50	58	73	114	355

PERFORMANS VERİLERİ | PERFORMANCE DATA

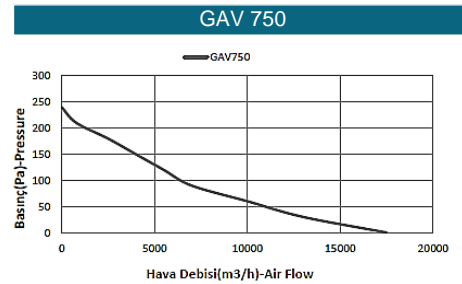
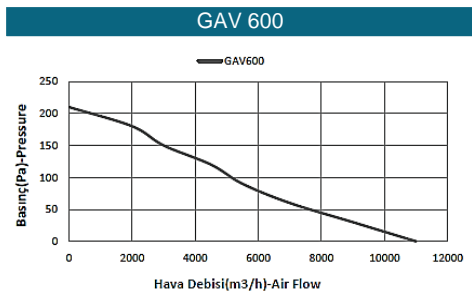



*Hız kontrol devreli



GAV TEKERLEKLİ VANTİLATÖRLER

Wheeled Ventilators

OPSİYONLAR:

•Trifaze Motorlu

OPTIONS:

With three-phase motor

FAN VERİLERİ | DATA

Tip/Typ	Voltaj Voltage	Frekans	Güç Power	Debi Air Flow	Devir Speed	Akım Current	Ağırlık Weight Net	Ağırlık Weight Gross	Pieces Box	İç Kutu Ölç. Inner Box Size	Dış Kutu Ölç. Outer Box Size	Fiyat/Price
	V	Hz	W/Kw	m³/saat	R.p.m.	A	Kg	Kg	Ad.	mm	mm	Usd
GAV 600T	230	50	250	10.000	1.400	0,90	18,00	19,00	1			\$425,00
GAV 750T	230	50	275	12500	1.400	1,20	20,00	21,00	1			\$475,00
GAV1000T	380	50	0,55	20.000	1.400	4,00	25,00	26,00	1			\$1.200,00

** HP MOTOR

TEKNİK ÇİZİM | TECHNICAL DRAWING

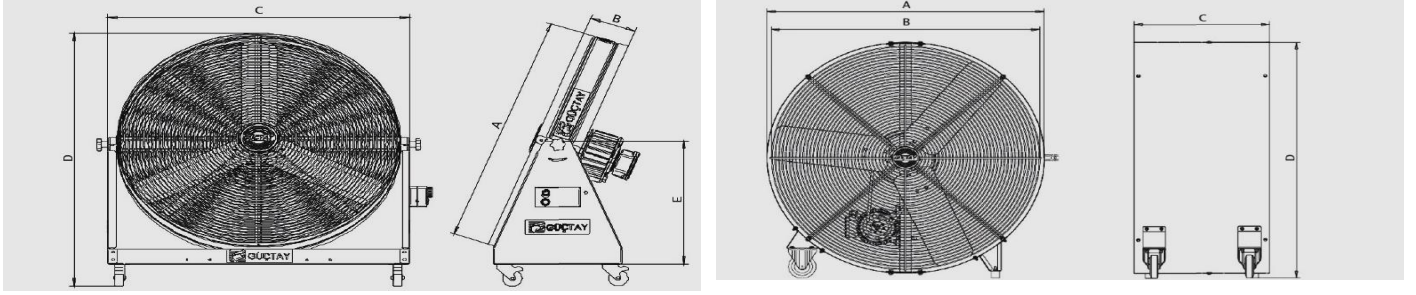

TEKNİK ÖLÇÜLER | TECHNICAL DIMENSIONS

Tüm Ölçüler mm'dir. | All dimensions are in mm

Tip / Type	A	B	C	D	E
GAV 600T	670	1055	1390	1460	1745
GAV 750T	820	1055	1465	1535	1820
GAV 1000T	1000	970	490	1050	

PERFORMANS VERİLERİ | PERFORMANCE DATA

GAV 600T

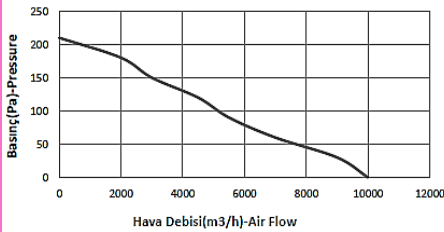

GAV 750T

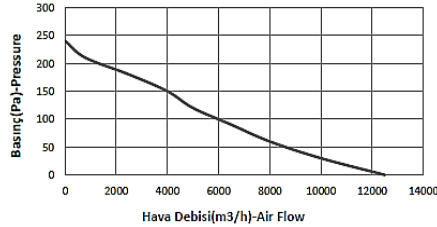

GAV 1000 T

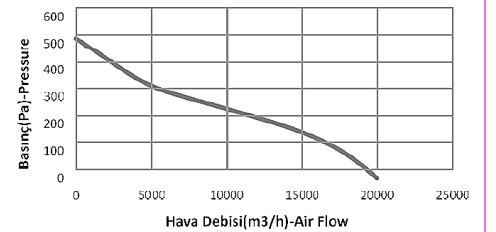



WPL ÇİFT YÖNLÜ PLASTİK FANLAR

Bidirectional Plastic Fans



FAN VERİLERİ | DATA

Tip/Typ	Voltaj Voltage	Frekans	Güç Power	Debi Air Flow	Devir Speed		Ağırlık Weight Net	Ağırlık Weight Gross	Pieces Box			Fiyat/Price
	V	Hz	Watt	m ³ /saat	R.p.m.		Kg	Kg	Ad.			Usd
WPL20	230	50	30	480	1.350		1,80	2,20	1			\$110,00
WPL25	230	50	40	720	1.350		2,10	2,60	1			\$130,00
WPL30	230	50	50	1080	1.350		2,50	2,9	1			\$150,00

TEKNİK ÇİZİM | TECHNICAL DRAWING

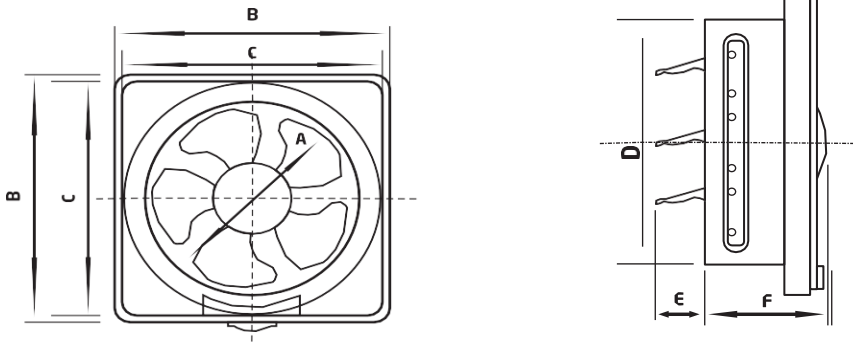

TEKNİK ÖLÇÜLER | TECHNICAL DIMENSIONS

Tüm Ölçüler mm'dir. | All dimensions are in mm

Tip / Type	A	B	C	D	E	F
WPL20	200	299	288	238	90	120
WPL25	250	344	338	288	80	125
WPL30	300	400	364	341	75	155



GKAF KARMA AKIŞLI PLASTİK FANLAR

In-line Plastic Duct Fans

FAN VERİLERİ | DATA

Tip/Typ	Voltaj Voltage	Frekans	Güç Power	Debi Air Flow	Devir Speed	Ağırlık Weight Net	Ağırlık Weight Gross	Pieces Box	Fiyat/Price	
	V	Hz	Watt	m³/saat	R.p.m.	Kg	Kg	Ad.	Usd	
GKAF 100	230	50	55	230	2.450	2,40	2,70	1	Fiyat Sorunuz	
GKAF 125	230	50	55	335	2.550	2,50	2,80	1	Fiyat Sorunuz	
GKAF 150	230	50	75	500	2.490	2,80	3,1	1	Fiyat Sorunuz	
GKAF 160	230	50	75	560	2.490	3,00	3,30	1	Fiyat Sorunuz	
GKAF 200	230	50	110	1.010	2.400	3,80	4,20	1	Fiyat Sorunuz	
GKAF 250	230	50	280	1.350	2.450	4,00	4,40	1	Fiyat Sorunuz	
GKAF 315	230	50	475	1.970	2.470	4,50	5,00	1	Fiyat Sorunuz	

TEKNİK ÇİZİM | TECHNICAL DRAWING

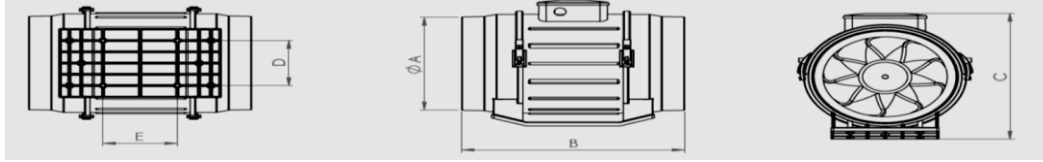

TEKNİK ÖLÇÜLER | TECHNICAL DIMENSIONS

Tüm Ölçüler mm'dir. | All dimensions are in mm

Tip / Type	A	B	C	D	E
GKAF 100	96	306,5	215	60	80
GKAF 125	121	260	215	60	80
GKAF 150	146	290,5	242	60	80
GKAF 160	156	271	242	60	80
GKAF 200	191	300	263	94	100
GKAF 250	246	393	325	110	140
GKAF 315	310	450	420	175	180

PERFORMANS VERİLERİ | PERFORMANCE DATA

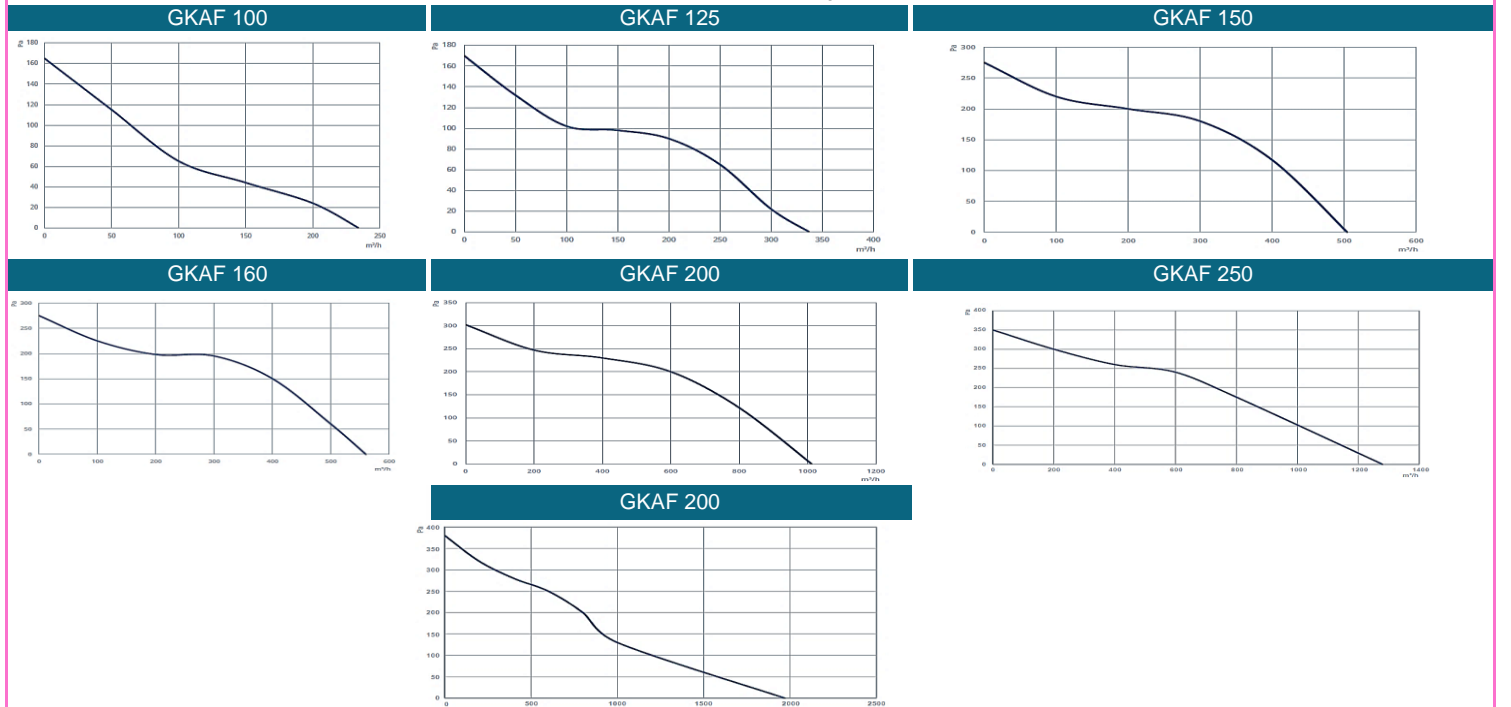



GDF YUVARLAK KANAL TİPİ RADYAL FANLAR

Circular Duct Fans

GENEL AÇIKLAMA

Ev içi ve ticari uygulamalar için idealdir. Güçlü hava akışı ve yüksek basınca sahiptir. Merkezi havalandırma için uygulanabilir. Kanal fanlarının her iki tarafı da kanala uyum sağlayarak kelepçeyle bağlanabilir. Her türlü montaj pozisyonunda çalıştırılabilir. Düşük ses seviyesine sahiptir. Yağlı ortamlarda filtreli kullanılması önerilir. Maksimum 60°C de ortam havasını temizlemek için kullanılır.

GENERAL DESCRIPTION

Suitable for domestic, commercial or industrial applications It has strong airflow and high pressure. Can be used for central ventilation. Both sides of the duct fans adapt to the duct. It can be operated in any mounting position. It is recommended to use a filter in oily environments. They are designed for clean air with maximum temperature 60°C

FAN VERİLERİ | DATA

Tip/Typ	Voltaj Voltage	Frekans	Güç Power	Debi Air Flow	Devir Speed	Akım Current	Ağırlık Weight Net	Ağırlık Weight Gross	Pieces Box	İç Kutu Ölç. Inner Box Size	Dış Kutu Ölç. Outer Box Size	Fiyat/Price
	V	Hz	Watt	m ³ /saat	R.p.m.	A	Kg	Kg	Ad.	mm	mm	Usd
GDF 100B	230	50	75	270	2.650	0,32	2,70	3,00	1		330*270*210	\$75,00
GDF 125B	230	50	80	350	2.400	0,39	2,90	3,30	1		330*270*210	\$80,00
GDF 150B	230	50	85	450	2.450	0,39	3,60	4,00	1		330*270*210	\$87,00
GDF 160B	230	50	90	670	2.450	0,40	3,60	4,20	1		330*270*210	\$89,00
GDF 200B	230	50	105	1.000	2.600	0,66	4,70	5,20	1		380*380*270	\$125,00
GDF 250B	230	50	150	1.250	2.640	0,73	5,00	5,50	1		380*380*270	\$139,00
GDF 315B	230	50	225	1.900	2.660	1,27	6,90	7,40	1		400*400*300	\$160,00

TEKNİK ÇİZİM | TECHNICAL DRAWING

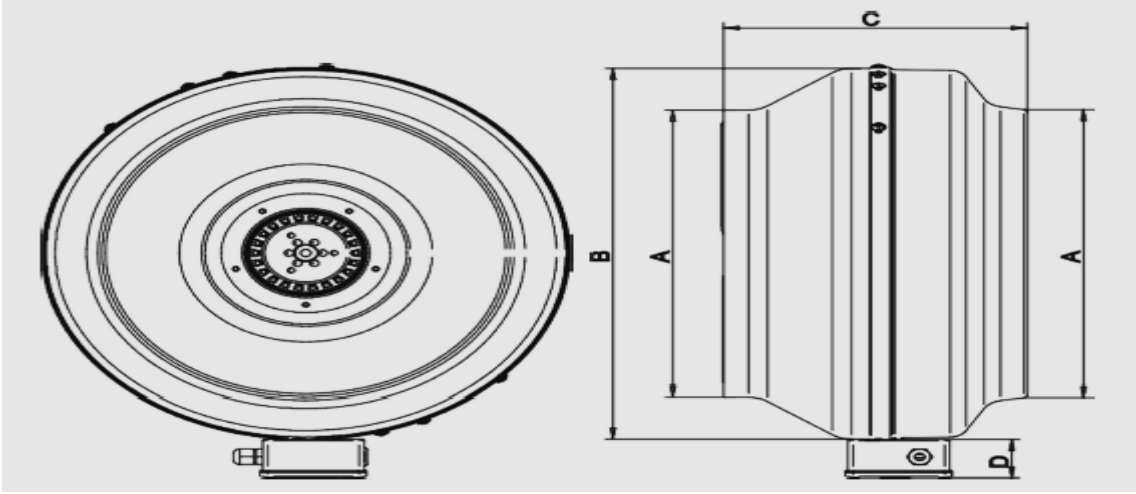

TEKNİK ÖLÇÜLER | TECHNICAL DIMENSIONS

Tüm Ölçüler mm'dir. | All dimensions are in mm

Tip / Type	A	B	C	D
GDF 100B	100	240	180	42
GDF 125B	125	240	180	42
GDF 150B	150	280	200	42
GDF 160B	160	280	200	42
GDF 200B	200	345	230	42
GDF 250B	250	345	230	42
GDF 315B	315	405	240	42

PERFORMANS VERİLERİ | PERFORMANCE DATA

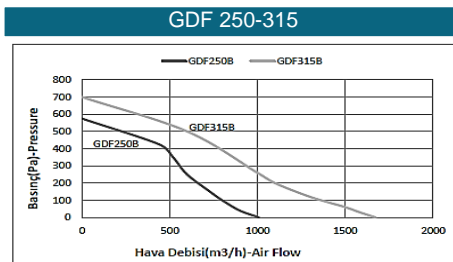
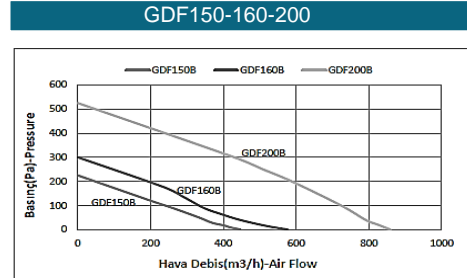
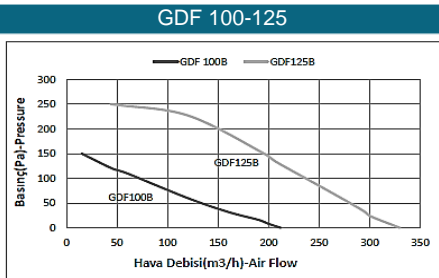

DİKDÖRTGEN KANAL TİPİ RADYAL FANLAR
Rectangular Duct Fans
GENEL AÇIKLAMA

Kanal fanı, dikdörtgen kanal sistemlerinde orta ve yüksek hacimde havalandırma ihtiyaçlarının karşılanması için tasarlanmıştır. Standart bakım kapakları sayesinde, cihazı sökmeden, kanal tesisatını demonte etmeden motor ve fan kanatlarına müdahale edilebilir. Ürünün bakımı yapılabilir. Dikdörtgen kanal tipi radyal fanlar galvaniz çelik sacdan imal edilmektedir.

GENERAL DESCRIPTION

The duct fan is designed to meet medium and high volume ventilation needs in rectangular duct systems. Thanks to the standard maintenance covers, the motor and fan blades can be intervened without disassembling the device or disassembling the ductwork. The product can be maintained. Rectangular duct type radial fans are manufactured with galvanized steel sheet.

FAN VERİLERİ | DATA

Tip/Typ	Voltaj Voltage	Frekans	Güç Power	Debi Air Flow	Devir Speed	Akım Current	Ağırlık Weight Net	Ağırlık Weight Gross	Pieces Box	İç Kutu Ölç. Inner Box Size	Dış Kutu Ölç. Outer Box Size	Fiyat/Price
	V	Hz	W/Kw	m ³ /saat	R.p.m.	A	Kg	Kg	Ad.	mm	mm	Usd
GRDKF 30-15	230	50	90	650	2.650		7,00		1		400*450*235	\$160,00
GRDKF 40-20A	230	50	150	950	2.400		10,50		1		500*455*285	\$220,00
GRDKF 40-20B	230	50	200	1.250	2.450		11,00		1		500*455*285	\$231,00
GRDKF 50-25	230	50	250	1.900	2.600		15,00		1		560*555*305	\$330,00
GRDKF 60-30	230	50	140	2.100	1.440		29,00		1		655*665*365	\$485,00
GRDKF 60-35A	230	50	160	2.700	1.400		31,00		1		725*665*415	\$515,00
GRDKF 60-35B	230	50	220	3.400	1.420		32,00		1		725*665*415	\$555,00
GRDKF 70-40A	230	50	560	4.800	1.450		44,00		1		805*765*465	\$770,00
GRDKF 70-40B	230	50	830	6.050	1.450		46,00		1		805*765*465	\$920,00
GRDKF 80-50	380	50	1560	8.500	1.360		66,00		1		905*865*565	\$1.250,00
GRDKF 100-50	380	50	1800	10.500	1.360		84,00		1		965*1065*565	\$1.550,00
** SEYREK KANATLI												
GDKF 315 HM	230/380	50	0,25	3.000	1.400		7,00		1			\$905,00
GDKF 355 HM	230/380	50	0,37	3.500	1.400		12,00		1			\$910,00
GDKF 400 HM	230/380	50	0,55	4.700	1.400		13,00		1			\$1.050,00
GDKF 450 HM	230/380	50	1,10	6.000	1.400		35,00		1			\$1.300,00
GDKF 500 HM	230/380	50	1,50	8.400	1.400		37,00		1			\$1.550,00
GDKF 560 HM	230/380	50	2,20	11.000	1.400		42,00		1			\$2.250,00

**** HP MOTORLU**
*****ÖNE EĞİMLİ 120° SÜREKLİ**

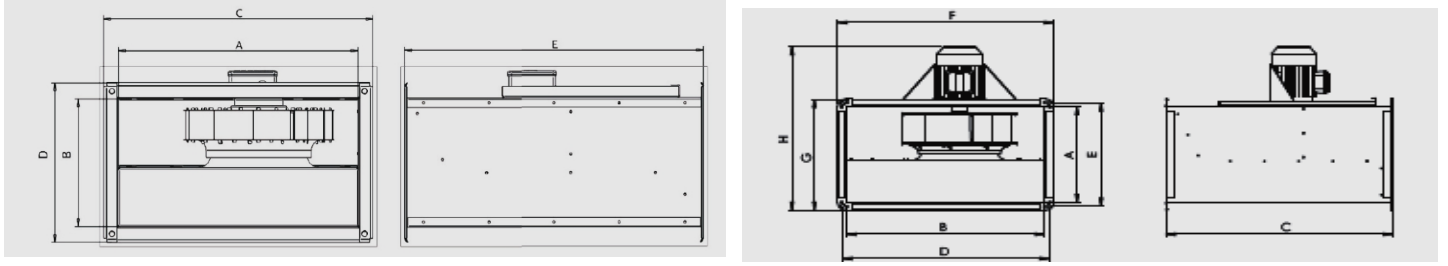
TEKNİK ÇİZİM | TECHNICAL DRAWING

TEKNİK ÖLÇÜLER | TECHNICAL DIMENSIONS

Tüm Ölçüler mm'dir. | All dimensions are in mm

Tip / Type	A	B	C	D	E
GRDKF 30-15	300	150	350	200	400
GRDKF 40-20A	400	200	450	250	495
GRDKF 40-20B	400	200	450	250	495
GRDKF 50-25	500	250	550	300	560
GRDKF 60-30	600	300	660	360	650
GRDKF 60-35A	600	350	660	410	720
GRDKF 60-35B	600	350	660	410	720
GRDKF 70-40A	700	400	760	460	800
GRDKF 70-40B	700	400	760	460	800
GRDKF 80-50	800	500	860	560	905
GRDKF 100-50	1000	500	1060	560	965

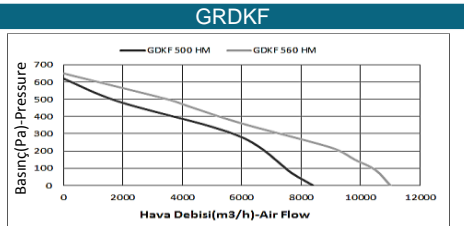
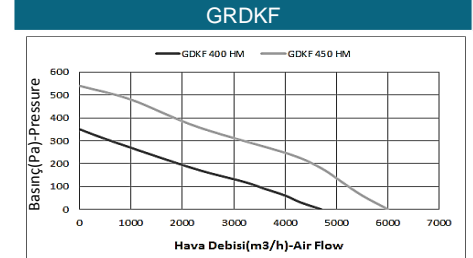
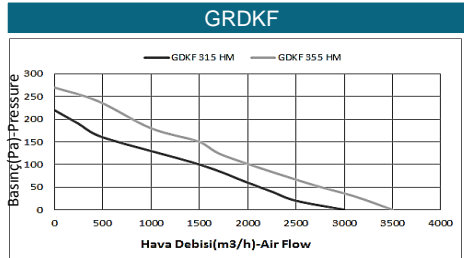
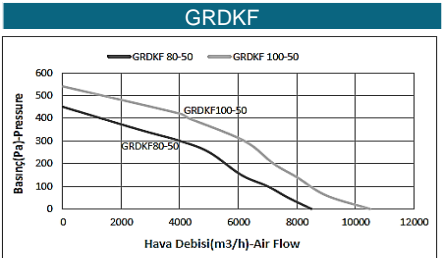
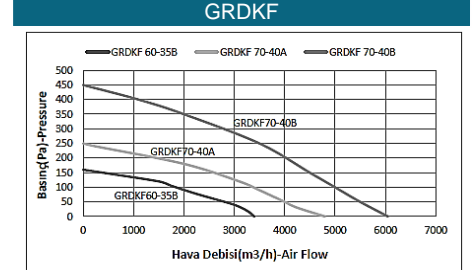
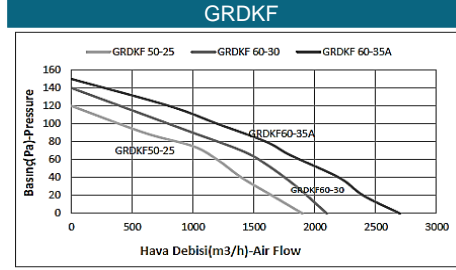
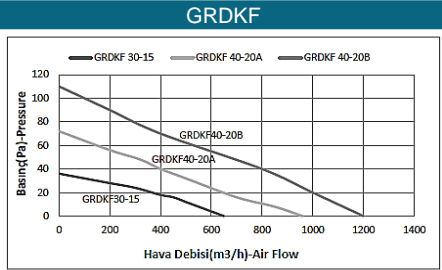
Tip / Type	A	B	C	D	E	F	G	H
GDKF 315 HM	350	600	750	620	370	660	410	600
GDKF 355 HM	350	600	750	620	370	660	410	600
GDKF 400 HM	400	700	800	720	420	770	470	657
GDKF 450 HM	400	700	800	720	420	770	470	675
GDKF 500 HM	500	800	920	820	520	870	570	795
GDKF 560 HM	500	1000	1050	1030	530	1070	570	855

PERFORMANS VERİLERİ | PERFORMANCE DATA



ÇATI FANLARI

Roof Fans

GENEL AÇIKLAMA

Çatı fanları; endüstriyel tesisler, mutfaklar, merdiven ve asansör boşluğu vb etkili emiş gerektiren alanlarda kullanılmaktadır. Motoru yağmurdan koruyan tavan sacı ve elektrostatik toz boyası sayesinde dış ortam şartlarında uzun süre çalışabilir.

GENERAL DESCRIPTION

Roof fans; It is used in industrial facilities, kitchens, stairs and elevator shafts, etc. that require effective suction. It can work for a long time in outdoor conditions thanks to the roof sheet that protects the engine from rain and electrostatic powder paint.

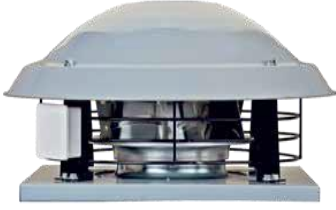

GRRF YATAY ATIŞLI RADYAL ÇATI TİPİ FANLAR

Radial Roof Fans

FAN VERİLERİ | DATA

Tip/Typ	Voltaj Voltage	Frekans	Güç Power	Debi Air Flow	Devir Speed	Akım Current	Ağırlık Weight Net	Ağırlık Weight Gross	Pieces Box	İç Kutu Ölç. Inner Box Size	Dış Kutu Ölç. Outer Box Size	Fiyat/Price
	V	Hz	Watt	m³/saat	R.p.m.	A	Kg	Kg	Ad.	mm	mm	Usd
GRRF 250	230	50	200	1.300	2.640		8,00		1			\$207,00
GRRF 315	230	50	250	1.800	2.660		12,80		1			\$320,00
GRRF 355	230	50	220	2.750	1.420		18,00		1			\$450,00
GRRF 400	230	50	560	3.620	1.450		22,00		1			\$665,00
GRRF 450	230	50	830	5.900	1.450		28,00		1			\$800,00
GRRF 500	230	50	1.560	8.000	1.360		45,50		1			\$1.130,00
GRRF 560	380	50	1.800	10.000	1.360		48,00		1			\$1.340,00

TEKNİK ÇİZİM | TECHNICAL DRAWING

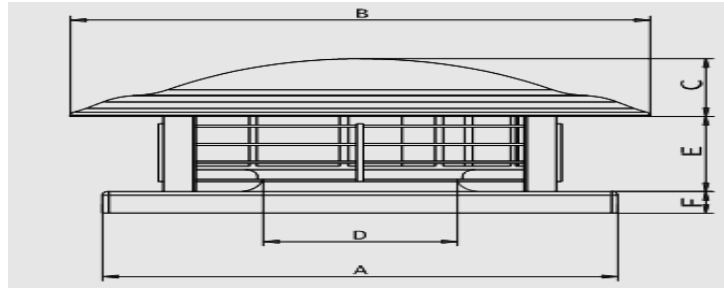

TEKNİK ÖLÇÜLER | TECHNICAL DIMENSIONS

Tüm Ölçüler mm'dir. | All dimensions are in mm

Tip / Type	A	B	C	D	E	F
GRRF 250	400	450	80	150	104	30
GRRF 315	400	450	80	150	104	30
GRRF 355	575	700	170	255	140	40
GRRF 400	575	700	170	255	215	40
GRRF 450	700	700	175	280	228	45
GRRF 500	800	910	90	325	245	45
GRRF 560	800	920	90	360	283	45

PERFORMANS VERİLERİ | PERFORMANCE DATA

GRRF250-315

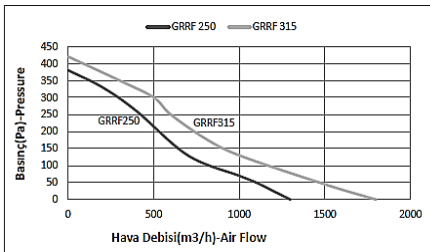

GRRF 355-400-450

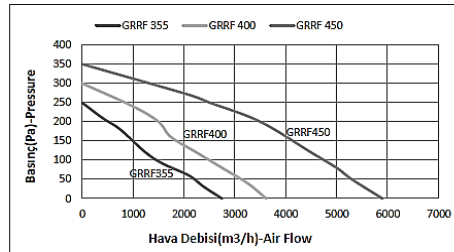

GRRF500-560

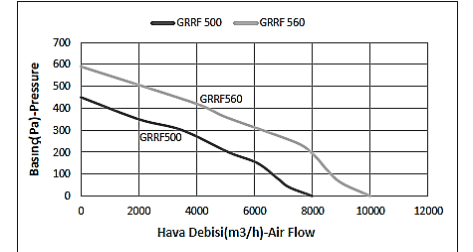



GRRF YATAY ATIŞLI AKSİYEL ÇATI TİPİ FANLAR

Axial Roof Fans

FAN VERİLERİ | DATA

Tip/Typ	Voltaj Voltage	Frekans	Güç Power	Debi Air Flow	Devir Speed		Ağırlık Weight Net	Ağırlık Weight Gross	Pieces Box			Fiyat/Price
	V	Hz	Kw	m ³ /saat	R.p.m.		Kg	Kg	Ad.			Usd
GRRF 400AX	380	50	0,37	1.200	1.450		30,00		1			\$843,00
GRRF 450AX	380	50	0,55	2.200	1.450		36,00		1			\$909,00
GRRF 500AX	380	50	0,55	3.900	1.450		42,00		1			\$950,00
GRRF 560AX	380	50	0,75	6.100	1.450		48,00		1			\$1.262,00
GRRF 630AX	380	50	1,10	11.000	1.450		55,00		1			\$1.426,00
GRRF 710AX	380	50	1,50	17.000	1.450		65,00		1			\$1.647,00
GRRF 800AX	380	50	2,20	22.000	1.450		70,00		1			\$2.061,00
GRRF 800AX	380	50	3,00	26.900	1.450		76,50		1			\$2.148,00
GRRF 900AX	380	50	4,00	34.000	1.450		100,00		1			\$2.747,00
GRRF 900AX	380	50	5,50	40.000	1.450		127,00		1			\$3.119,00
GRRF 1000AX	380	50	7,50	49.500	1.450		175,00		1			\$3.485,00
GRRF 900AX	380	50	11,00	43.000	1.450		240,00		1			\$3.983,00
GRRF 1000AX	380	50	15,00	58.800	1.450				1			\$4.930,00
GRRF 1000AX	380	50	18,50	66.000	1.450				1			\$5.717,00
GRRF 1120AX	380	50	22,00	84.600	1.450				1			\$8.316,00
GRRF 1120AX	380	50	30,00	92.000	1.450				1			\$9.652,00

TEKNİK ÇİZİM | TECHNICAL DRAWING

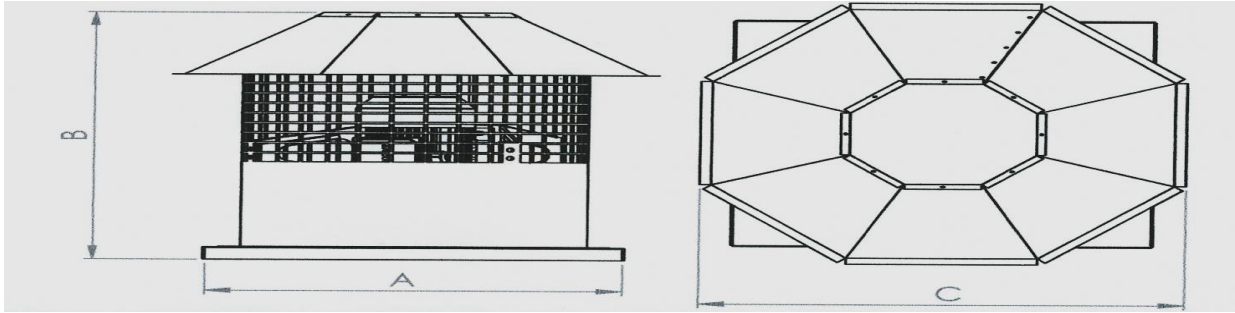

TEKNİK ÖLÇÜLER | TECHNICAL DIMENSIONS

Tüm Ölçüler mm'dir. | All dimensions are in mm

Tip / Type	A	C	
GRRF 400AX	500	800	640
GRRF 450AX	550	800	640
GRRF 500AX	600	800	700
GRRF 560AX	650	800	760
GRRF 630AX	750	850	850
GRRF 710AX	850	850	950
GRRF 800AX	950	850	1070
GRRF 900AX	1050	1200	1140
GRRF 1000AX	1150	1200	1240
GRRF 1120AX	1250	1550	1390

PERFORMANS VERİLERİ | PERFORMANCE DATA

GRRF400AX

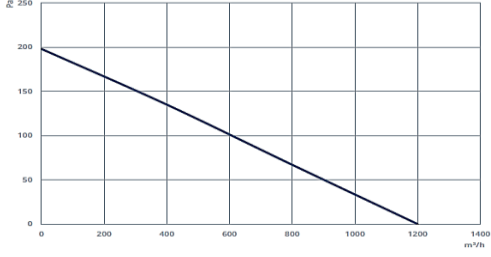

GRRF450AX

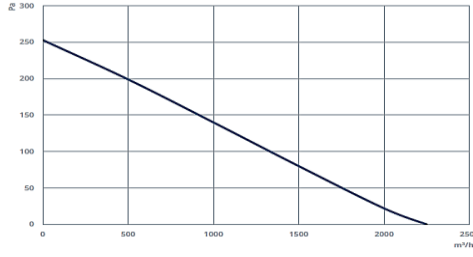

GRRF500AX

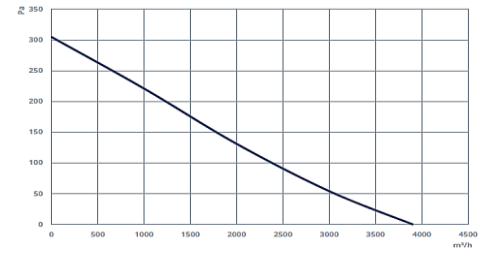

GRRF560AX

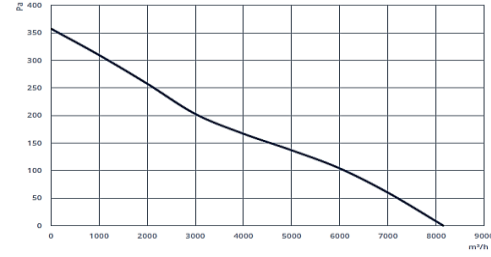

GRRF630AX

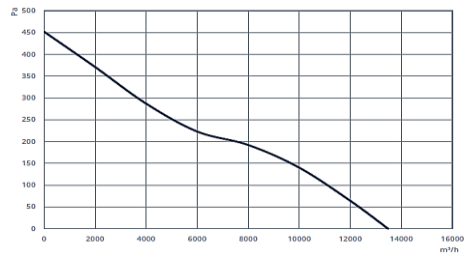

GRRF710AX

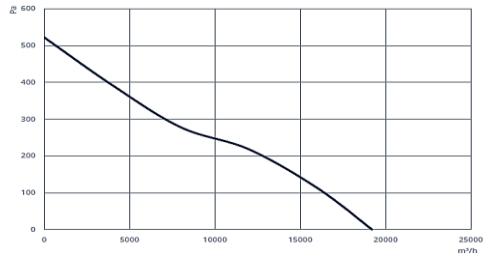

GRRF800AX-5-30

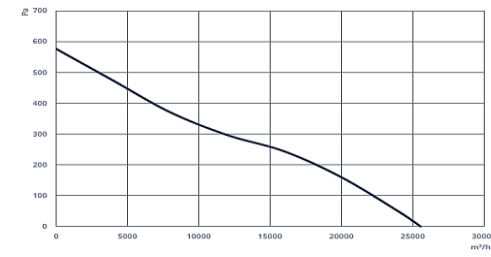

GRRF800AX-5-35

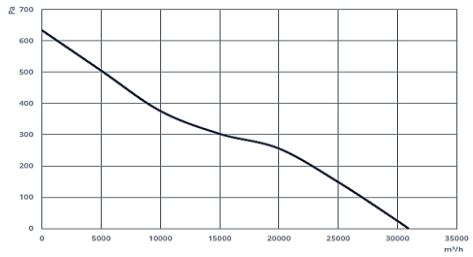

GRRF900AX-5-35

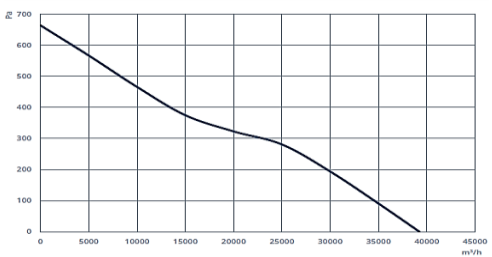

GRRF900AX-5-40

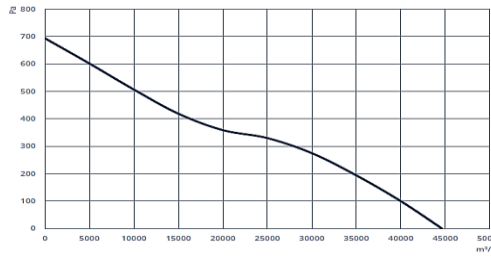

GRRF1000AX-5-40

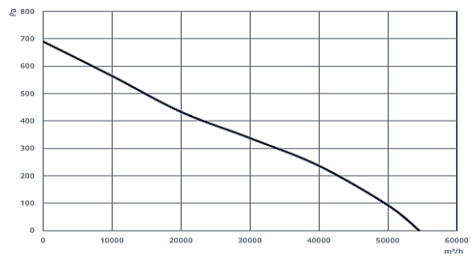

GRRF900AX-8-40

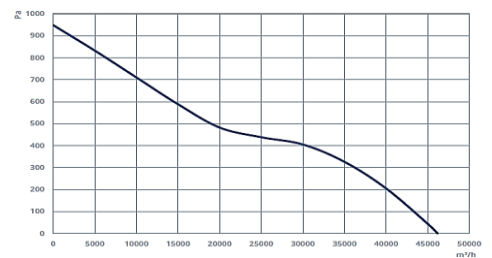

GRRF1000AX-8-40

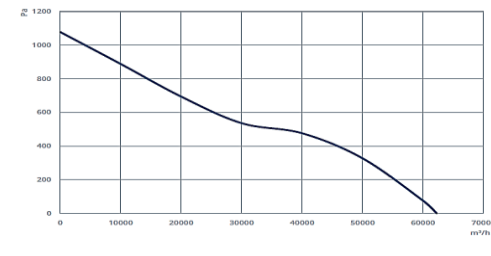

GRRF1000AX-8-45

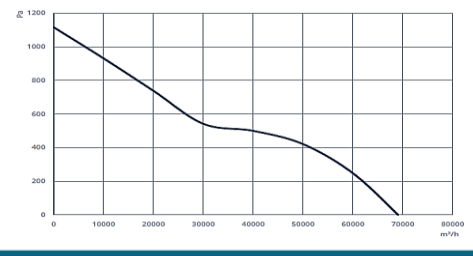

GRRF1120AX-8-40

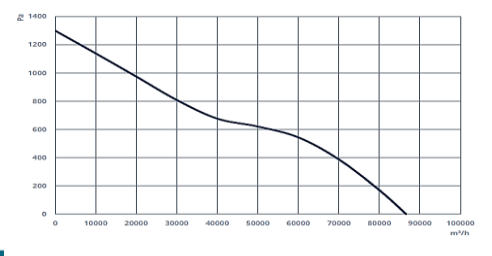

GRRF1120AX-8-45

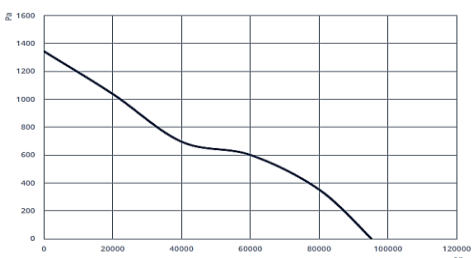



GRCFM YATAY ATIŞLI RADYAL ÇATI TİPİ FAN

FAN VERİLERİ | DATA

Tip/Typ	Voltaj Voltage	Frekans	Güç Power	Debi Air Flow	Devir Speed	Akım Current	Ağırlık Weight Net	Ağırlık Weight Gross	Pieces Box	İç Kutu Ölç. Inner Box Size	Dış Kutu Ölç. Outer Box Size	Fiyat/Price
	V	Hz	Watt	m³/saat	R.p.m.	A	Kg	Kg	Ad.	mm	mm	Usd
GRCFM 315	230/380	50	550,00	1800	2800	0,85	11,00		1			\$360



GRCF YATAY ATIŞLI RADYAL ÇATI TİPİ FANLAR

FAN VERİLERİ | DATA

Tip/Typ	Voltaj Voltage	Frekans	Güç Power	Debi Air Flow	Devir Speed		Ağırlık Weight Net	Ağırlık Weight Gross	Pieces Box			Fiyat/Price
	V	Hz	Watt	m³/saat	R.p.m.		Kg	Kg	Ad.			Usd
GRCF 190	230	50	90	520	2.600		6		1			\$175,00
GRCF 225	230	50	104	950	2.675		8		1			\$205,00
GRCF 250	230	50	130	1.150	2.685		10		1			\$229,00
GRCF 280	230	50	180	2.000	2.615		12		1			\$325,00
GRCF 355	230	50	185	2.350	1.365		25		1			\$545,00
GRCF 400	230	50	380	3.400	1.365		32		1			\$728,00
GRCF 450	230	50	690	4.900	1.365		40		1			\$915,00
GRCF 500	230/380	50	1.080	7.000	1.365		52		1			\$1.203,00
GRCF 560	380	50	1.670	9.300	1.365		60		1			\$1.385,00



RADYAL FANLAR Radial Fans

GENEL AÇIKLAMA

Radyal fanlar, fabrikalar, depolar, boyahaneler vb. alanlarda; toz toplama, duman ve egzost tahliyesinde, ince tanecikli toz naklinde havalandırma amacıyla kullanılır. Direkt akuple motorlu, (Monofaze & Trifaze) dkp sacdan imal edilmiş, öne eğik kanatlı fanlardır. Talep üzerine paslanmaz çelikten ve kayış kasnak tahrikli olarak imal edilebilir. Fan kanatları aerodinamik olarak kavislidir ve düzenli hava akışı sağlar. Vidalama sistemi ile kasa istenen atış pozisyonuna çevrilebilir.

GENERAL DESCRIPTION

In areas such as radial fans, factories, warehouses, paint shops, etc.; It is used in dust collection, smoke and exhaust evacuation, fine-grained dust transport ventilation. They are fans with direct coupled motor, (Monophase & Three-phase) made of dkp sheet metal, with forward curved blades. It can be manufactured from stainless steel and with belt pulley drive upon request. Fan blades are aerodynamically curved and provide regular airflow. With the screwing system, the safe can be easily turned to the desired shooting position.

FAN EMİŞ-ATIŞ YÖNLERİ

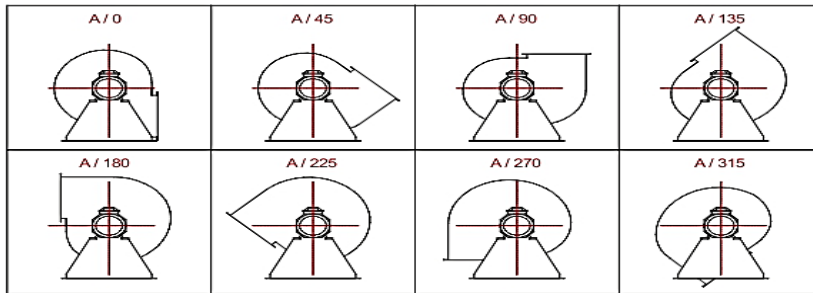

SOL YÖN A



SAĞ YÖN B

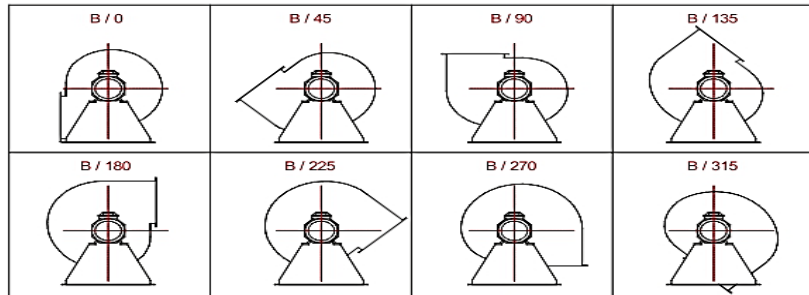



GABRF ALÇAK BASINÇLI TEK EMİŞLİ RADYAL FANLAR

Radial Fans (low pressure)

FAN VERİLERİ | DATA

Tip/Typ	Voltaj Voltage	Frekans	Güç Power	Debi Air Flow	Devir Speed	Basınç/ Pressure	Ağırlık Weight Net	Ağırlık Weight Gross	Pieces Box	İç Kutu Ölç. Inner Box Size	Dış Kutu Ölç. Outer Box Size	Fiyat/Price
	V	Hz	Kw	m ³ /saat	R.p.m.	mmss	Kg	Kg	Ad.	mm	mm	Usd
GABRF-2 1hp	380	50	0,75	2.500	1.450	30			1			\$1.000,00
GABRF-3 1,5hp	380	50	1,10	3.500	1.450	40			1			\$1.150,00
GABRF-4 2hp	380	50	1,50	4.500	1.450	55			1			\$1.300,00
GABRF-5 3hp	380	50	2,20	6.000	1.450	75			1			\$1.600,00
GABRF-6 4hp	380	50	3,00	6.500	1.450	90			1			\$1.800,00
GABRF-7 5,5hp	380	50	4,00	7.500	1.450	100			1			\$2.150,00
GABRF-8 7,5hp	380	50	5,50	9.500	1.450	110			1			\$2.800,00
GABRF-9 10hp	380	50	7,50	12.000	1.450	125			1			\$3.350,00
GABRF-10 11hp	380	50	11,00	15.000	1.450	150			1			\$3.900,00

TEKNİK ÇİZİM | TECHNICAL DRAWING

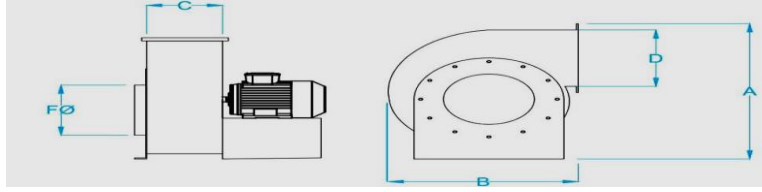

TEKNİK ÖLÇÜLER | TECHNICAL DIMENSIONS

Tüm Ölçüler mm'dir. | All dimensions are in mm

Tip / Type	A	B	C	D	F
GABRF-2 1hp	570	400	180	230	200
GABRF-3 1,5hp	650	500	200	260	240
GABRF-4 2hp	700	550	230	280	260
GABRF-5 3hp	750	590	230	300	280
GABRF-6 4hp	750	600	250	320	300
GABRF-7 5,5hp	810	640	250	340	320
GABRF-8 7,5hp	920	740	300	390	350
GABRF-9 10hp	990	800	320	420	380
GABRF-10 11hp	1050	895	350	440	420

PERFORMANS VERİLERİ | PERFORMANCE DATA

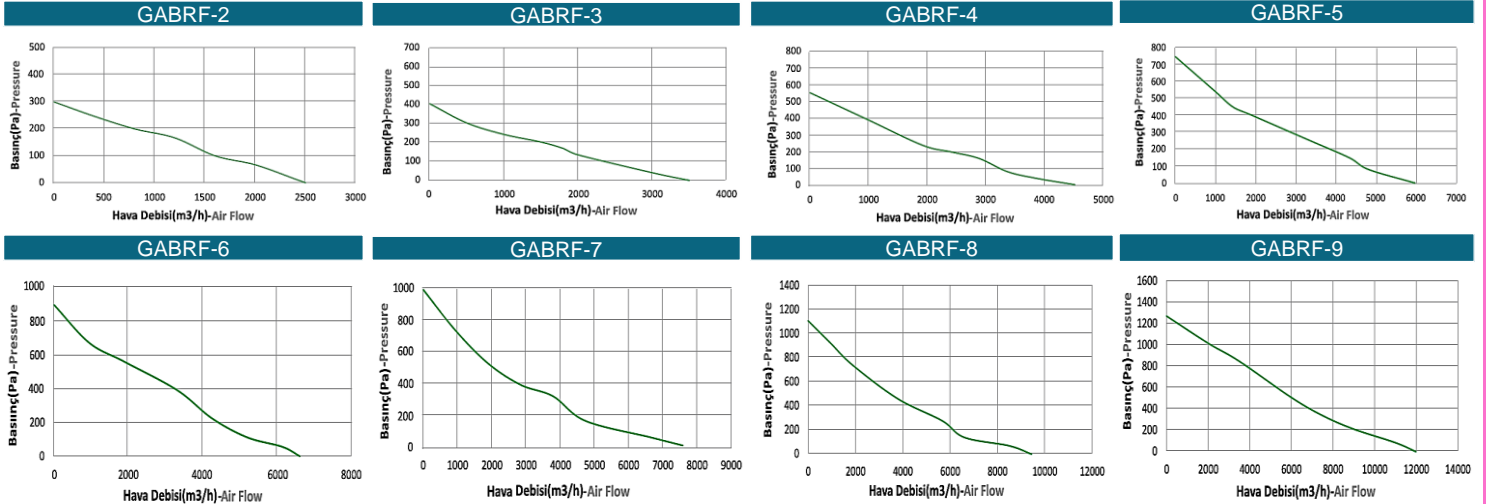



GOBRF ORTA BASINÇLI RADYAL FANLAR

Radial Fans (medium pressure)

FAN VERİLERİ | DATA

Tip/Type	Voltaj Voltage	Frekans	Güç Power	Debi Air Flow	Devir Speed	Basınç/ Pressure	Ağırlık Weight Net	Ağırlık Weight Gross	Pieces Box	İç Kutu Ölç. Inner Box Size	Dış Kutu Ölç. Outer Box Size	Fiyat/Price
	V	Hz	Kw	m³/saat	R.p.m.	mmss	Kg	Kg	Ad.	mm	mm	Usd
GOBRF-2 1hp	380	50	0,75	1.000	2.850	140			1			\$1.000,00
GOBRF-3 1,5hp	380	50	1,10	1.250	2.850	160			1			\$1.150,00
GOBRF-4 2hp	380	50	1,50	1.500	2.850	180			1			\$1.300,00
GOBRF-5 3hp	380	50	2,20	2.000	2.850	200			1			\$1.600,00
GOBRF-6 4hp	380	50	3,00	2.425	2.850	220			1			\$1.800,00
GOBRF-7 5,5hp	380	50	4,00	2.850	2.850	270			1			\$2.150,00
GOBRF-8 7,5hp	380	50	5,50	4.000	2.850	325			1			\$2.800,00
GOBRF-9 10hp	380	50	7,50	5.750	2.850	400			1			\$3.350,00
GOBRF-10 11hp	380	50	11,00	7.500	2.850	500			1			\$3.900,00

TEKNİK ÇİZİM | TECHNICAL DRAWING

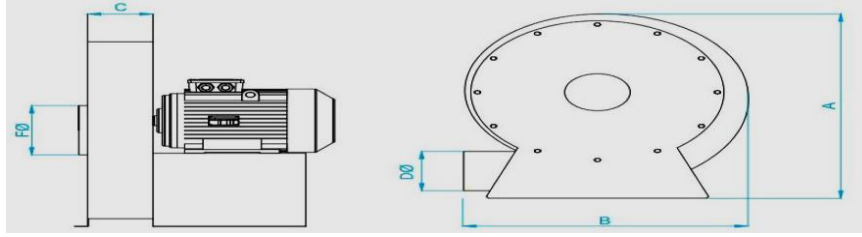

TEKNİK ÖLÇÜLER | TECHNICAL DIMENSIONS

Tüm Ölçüler mm'dir. | All dimensions are in mm

Tip / Type	A	B	C	D	F
GOBRF-2 1hp	500	580	100	100	130
GOBRF-3 1,5hp	530	610	100	100	140
GOBRF-4 2hp	530	620	120	120	150
GOBRF-5 3hp	590	650	120	120	170
GOBRF-6 4hp	660	700	150	150	180
GOBRF-7 5,5hp	670	710	150	150	190
GOBRF-8 7,5hp	750	780	150	150	200
GOBRF-9 10hp	790	820	180	180	220
GOBRF-10 11hp	860	890	200	200	220

PERFORMANS VERİLERİ | PERFORMANCE DATA

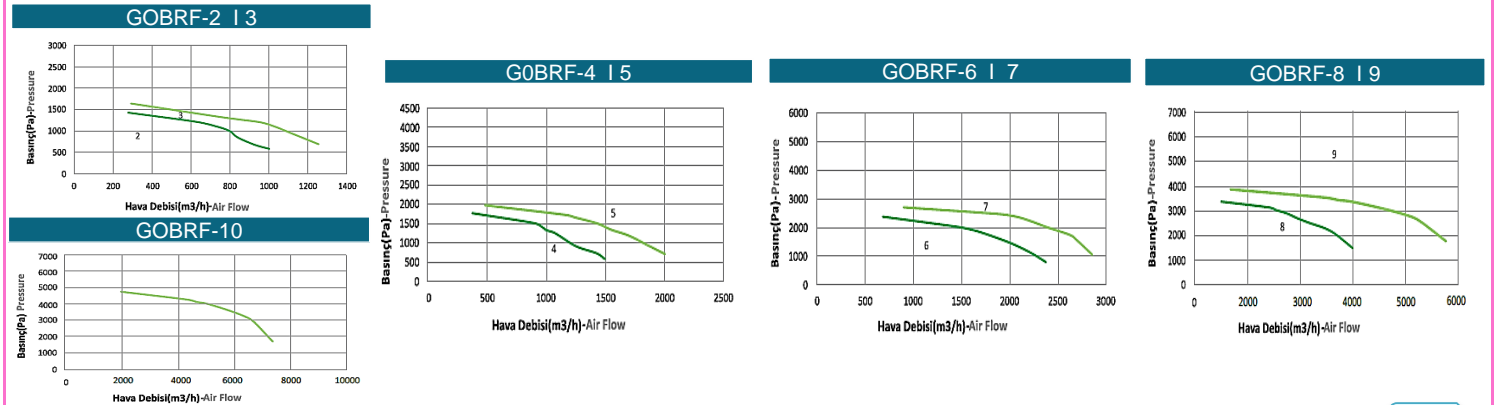



GYBKF YÜKSEK BASINÇLI RADYAL FANLAR

Radial Fans (high pressure)

FAN VERİLERİ | DATA

Tip/Typ	Voltaj Voltage	Frekans	Güç Power	Debi Air Flow	Devir Speed	Basınç/ Pressure	Ağırlık Weight Net	Ağırlık Weight Gross	Pieces Box	İç Kutu Ölç. Inner Box Size	Dış Kutu Ölç. Outer Box Size	Fiyat/Price
	V	Hz	Kw	m³/saat	R.p.m.	mmss	Kg	Kg	Ad.	mm	mm	Usd
GYBRF-2 1hp	380	50	0,75	400	2.850	150			1			\$1.000,00
GYBRF-3 1,5hp	380	50	1,10	500	2.850	225			1			\$1.150,00
GYBRF-4 2hp	380	50	1,50	600	2.850	290			1			\$1.300,00
GYBRF-5 3hp	380	50	2,20	650	2.850	375			1			\$1.600,00
GYBRF-6 4hp	380	50	3,00	775	2.850	425			1			\$1.800,00
GYBRF-7 5,5hp	380	50	4,00	900	2.850	575			1			\$2.150,00
GYBRF-8 7,5hp	380	50	5,50	1.150	2.850	700			1			\$2.800,00
GYBRF-9 10hp	380	50	7,50	1.300	2.850	800			1			\$3.350,00
GYBRF-10 11hp	380	50	11,00	1.500	2.850	1000			1			\$3.900,00

TEKNİK ÇİZİM | TECHNICAL DRAWING

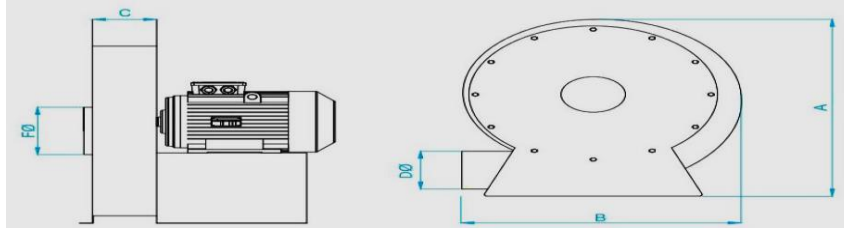

TEKNİK ÖLÇÜLER | TECHNICAL DIMENSIONS

Tüm Ölçüler mm'dir. | All dimensions are in mm

Tip / Type	A	B	C	D	F
GYBRF-2 1hp	590	630	70	70	120
GYBRF-3 1,5hp	600	620	70	70	130
GYBRF-4 2hp	630	710	70	70	140
GYBRF-5 3hp	690	720	80	80	150
GYBRF-6 4hp	720	710	80	80	160
GYBRF-7 5,5hp	750	820	80	80	170
GYBRF-8 7,5hp	810	780	100	100	180
GYBRF-9 10hp	870	860	100	100	190
GYBRF-10 11hp	1040	930	110	100	200

PERFORMANS VERİLERİ | PERFORMANCE DATA

GYBRF 2 | 3

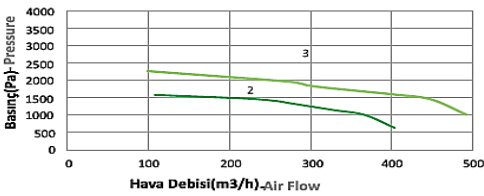

GYBRF 4 | 5

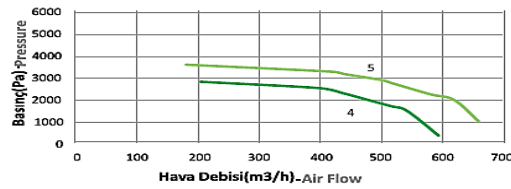

GYBRF-10

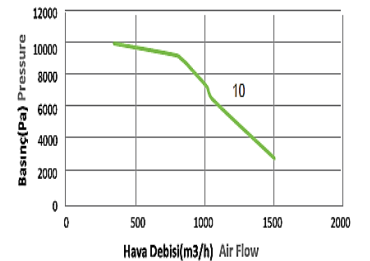

GYBRF 6 | 7

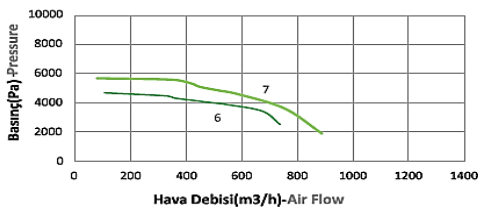

GYBRF 8 | 9

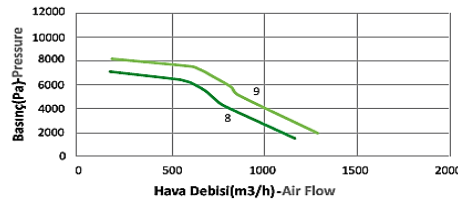

GSFM-GSFT SALYANGOZ FANLAR
Radial Fans
FAN VERİLERİ | DATA

Tip/Typ	Voltaj Voltage	Frekans	Güç Power	Debi Air Flow	Devir Speed	Akım Current	Ağırlık Weight Net	Ağırlık Weight Gross	Pieces Box	İç Kutu Ölç. Inner Box Size	Dış Kutu Ölç. Outer Box Size	Fiyat/Price
	V	Hz	Watt	m ³ /saat	R.p.m.	A	Kg	Kg	Ad.	mm	mm	Usd
GSFM 1400	230	50	375	1.250	1.400	0,76	8,50	9,00	1	350*510*360		\$207,00
GSFM 2800	230	50	570	1.580	2.800	2,50	8,50	9,00	1	350*510*360		\$207,00
GSFT 1400	380	50	375	1.250	1.400	0,65	8,50	9,00	1	350*510*360		\$207,00
GSFT 2800	380	50	570	1.580	2.800	0,70	8,50	9,00	1	350*510*360		\$207,00
GSFM 1400-SK	230	50	375	1.250	1.400	0,76	8,50	9,00	1	350*510*360		\$235,00
GSFM 2800-SK	230	50	570	1.580	2.800	2,50	8,50	9,00	1	350*510*360		\$235,00
GSFT 1400-SK	380	50	375	1.250	1.400	0,65	8,50	9,00	1	350*510*360		\$235,00
GSFT 2800-SK	380	50	570	1.580	2.800	0,70	8,50	9,00	1	350*510*360		\$235,00

** SEYREK KANATLI

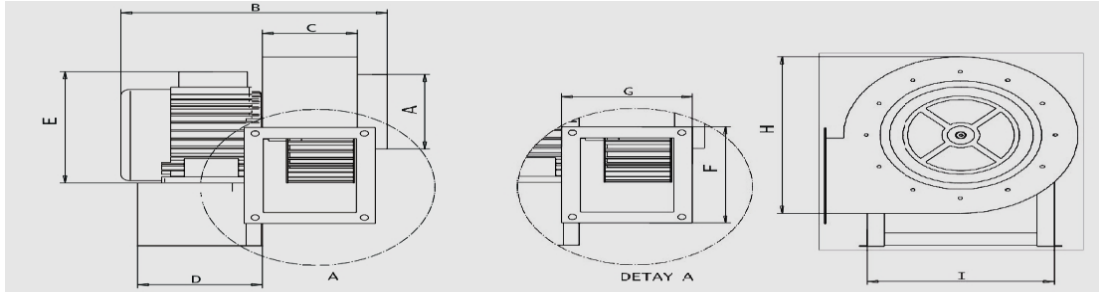
TEKNİK ÇİZİM | TECHNICAL DRAWING

TEKNİK ÖLÇÜLER | TECHNICAL DIMENSIONS

Tüm Ölçüler mm'dir. | All dimensions are in mm

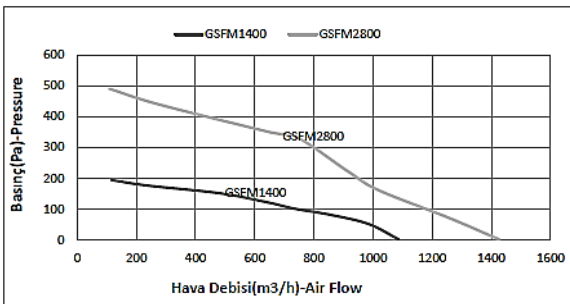
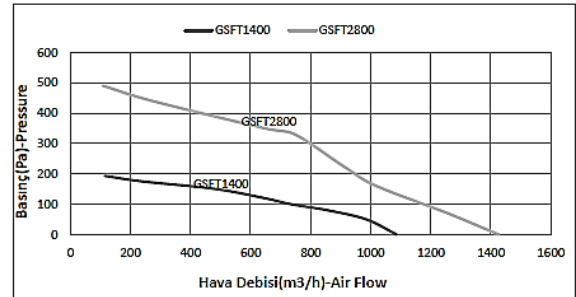
Tip / Type	A	B	C	D	E	F	G	H	I
GSFM 1400	160	322	105	154	196	160	148	290	203
GSFM 2800	160	322	105	154	196	160	148	290	203
GSFT 1400	160	322	105	154	196	160	148	290	203
GSFT 2800	160	322	105	154	196	160	148	290	203

PERFORMANS VERİLERİ | PERFORMANCE DATA
GYBK-2 | GYBK-3

GYBK-4 | GYBK-5



GOBR TEK EMİŞLİ RADYAL FANLAR

Radial Fans

FAN VERİLERİ | DATA

Tip/Typ	Voltaj Voltage	Frekans	Güç Power	Debi Air Flow	Devir Speed	Akım Current	Ağırlık Weight Net	Ağırlık Weight Gross	Pieces Box	İç Kutu Ölç. Inner Box Size	Dış Kutu Ölç. Outer Box Size	Fiyat/Price
	V	Hz	Watt	m³/saat	R.p.m.	A	Kg	Kg	Ad.	mm	mm	Usd
GOBR 140	230/380	50	225	1.200	2.800	1,20	7,20	8,00	1		390*370*380	\$195,00
GOBR 160	230/380	50	225	1.500	2.800	1,20	7,50	8,30	1		390*370*380	\$205,00
GOBR 260M HP	230	50	0,75	2.700	2.730	6,00	13,80	14,60	1		390*370*380	\$590,00
GOBR 260M	230	50	330	1.450	1.375	1,50	9,50	10,20	1		390*370*380	\$260,00
GOBR 260T HP	380	50	0,75	2.700	2.730	2,00	13,80	14,60	1		390*370*380	\$560,00
GOBR 260T	380	50	290	1.450	1.375	0,82	9,80	10,30	1		390*370*380	\$250,00

TEKNİK ÇİZİM | TECHNICAL DRAWING

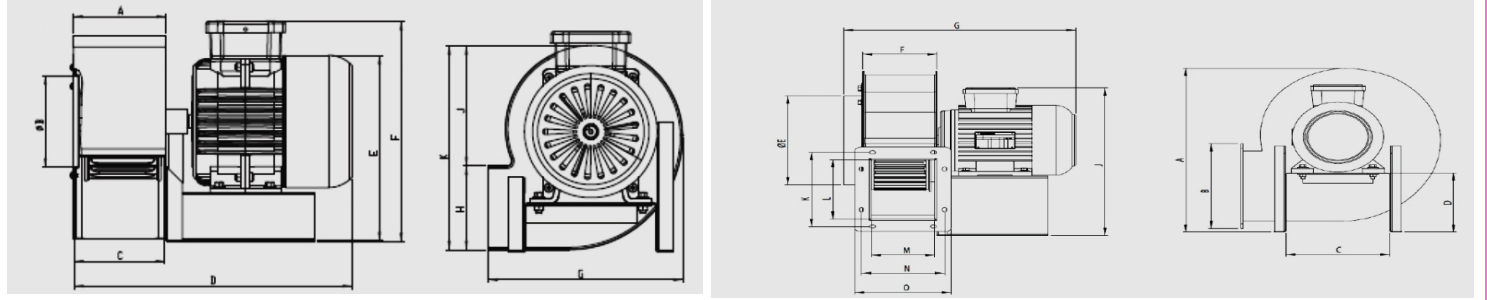

TEKNİK ÖLÇÜLER | TECHNICAL DIMENSIONS

Tüm Ölçüler mm'dir. | All dimensions are in mm

Tip / Type	A	B	C	D	E	F	G	H	J	K	L	M	N	O
GOBR	103	102	102	294	200	240	204	91	125	216	0	0		0
GOBR 260	361	194	155	119	197	128	405	327	162	137	137	115	141	163

PERFORMANS VERİLERİ | PERFORMANCE DATA

GOBR -140

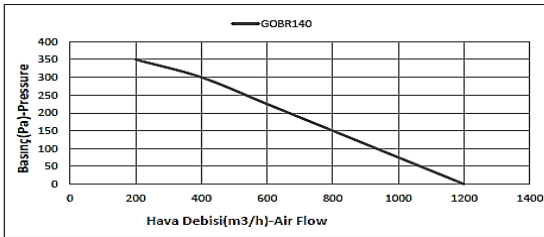

GOBR - 160

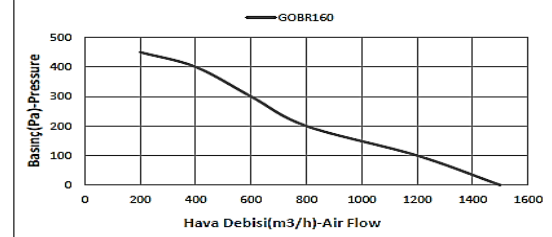

GOBR 260M HP | GOBR 260T HP

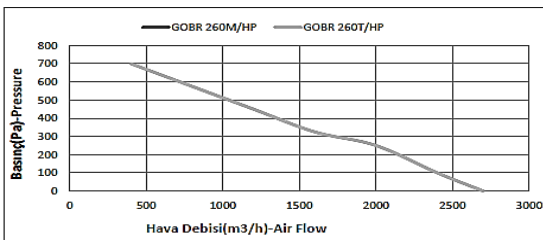

GOBR 260M | GOBR 260T

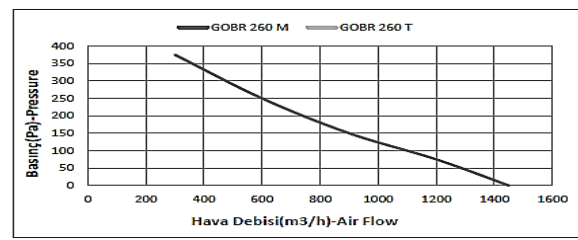

GSRFA SALYANGOZ FANLAR ALÜMİNYUM GÖVDELİ
Radial Fans (aluminium body)

FAN VERİLERİ | DATA

Tip/Typ	Voltaj Voltage	Frekans	Güç Power	Debi Air Flow	Devir Speed	Akım Current	Ağırlık Weight Net	Ağırlık Weight Gross	Pieces Box	İç Kutu Ölç. Inner Box Size	Dış Kutu Ölç. Outer Box Size	Fiyat/Price
	V	Hz	Watt	m ³ /saat	R.p.m.	A	Kg	Kg	Ad.	mm	mm	Usd
GSRFA 120-60	230	50	90	380	2.450	0,50	2,20	2,30	1		130*195*245	\$89,00
GSRFA 140-60	230	50	160	600	2.300	0,54	3,00	3,20	1		145*275*265	\$99,00
GSRFA 160-60	230	50	225	750	2.200	0,70	4,00	4,20	1		145*275*280	\$119,00

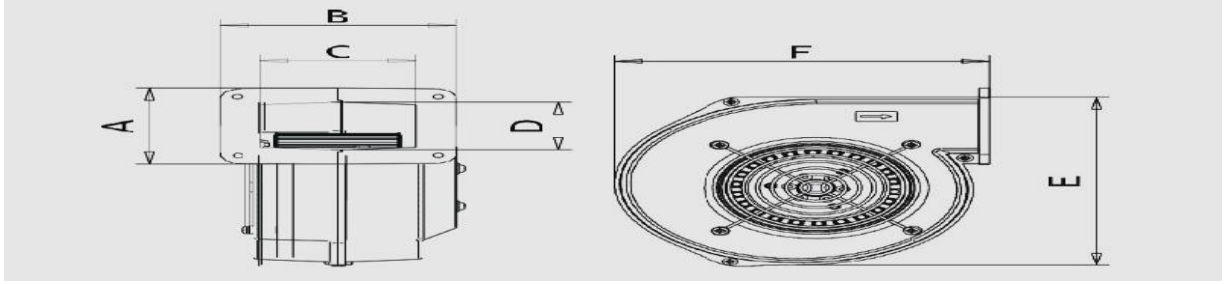
TEKNİK ÇİZİM | TECHNICAL DRAWING

TEKNİK ÖLÇÜLER | TECHNICAL DIMENSIONS

Tüm Ölçüler mm'dir. | All dimensions are in mm

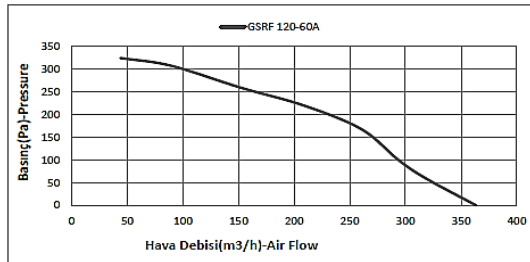
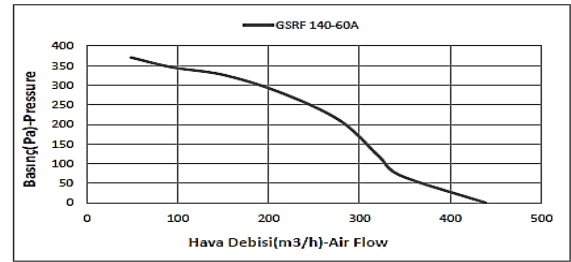
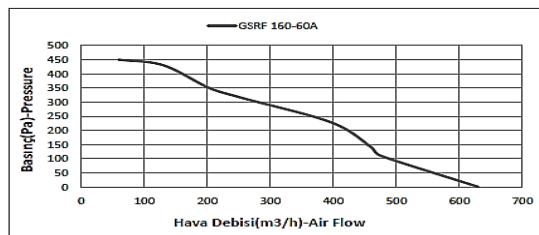
Tip / Type	A	B	C	D	E	F
GSRFA 120-60	83	115	76	50	180	180
GSRFA 140-60	122,5	131	95	92	255	235
GSRFA 160-60	125	135	100	100	270	265

PERFORMANS VERİLERİ | PERFORMANCE DATA
GSRFA 120-60

GSRFA 140-60

GSRFA 160-60

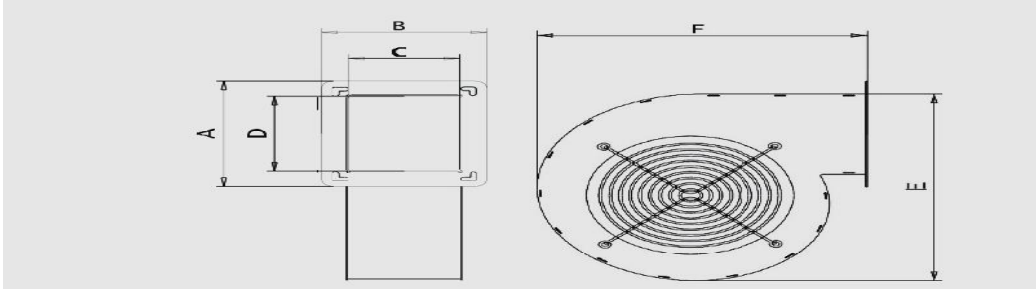

GSRFS SALYANGOZ FANLAR SAC GÖVDELİ
Radial Fans (metal body)
FAN VERİLERİ | DATA

Tip/Typ	Voltaj Voltage	Frekans	Güç Power	Debi Air Flow	Devir Speed	Akım Current	Ağırlık Weight Net	Ağırlık Weight Gross	Pieces Box	İç Kutu Ölç. Inner Box Size	Dış Kutu Ölç. Outer Box Size	Fiyat/Price
	V	Hz	Watt	m ³ /saat	R.p.m.	A	Kg	Kg	Ad.	mm	mm	Usd
GSRFS 120-60	230	50	90	380	2.450	0,50	2,00	2,20	1		130*195*245	\$84,00
GSRFS 140-60	230	50	160	600	2.300	0,54	2,40	2,60	1		145*275*265	\$95,00
GSRFS 160-60	230	50	225	750	2.200	0,70	3,30	3,50	1		145*275*280	\$115,00

TEKNİK ÇİZİM | TECHNICAL DRAWING

TEKNİK ÖLÇÜLER | TECHNICAL DIMENSIONS

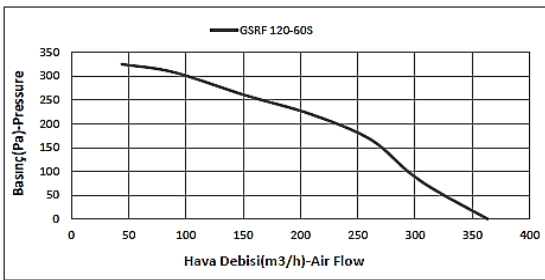
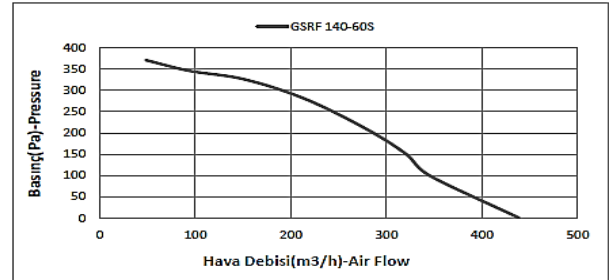
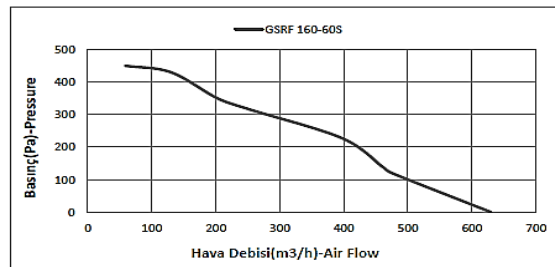
Tüm Ölçüler mm'dir. | All dimensions are in mm

Tip / Type	A	B	C	D	E	F
GSRFS 120-60	101,5	116,50	80,50	64,50	180	180
GSRFS 140-60	134	116	82,50	100	240	230
GSRFS 160-60	135	116,50	82,50	100	240	230

PERFORMANS VERİLERİ | PERFORMANCE DATA
GSRF 120-60

GSRF 140-60

GSRF 160-60



GKMS-GKTS TEK EMİŞLİ RADYAL FANLAR

Radial Fans (metal body)

FAN VERİLERİ | DATA

Tip/Typ	Voltaj Voltage	Frekans	Güç Power	Debi Air Flow	Devir Speed	Akım Current	Ağırlık Weight Net	Ağırlık Weight Gross	Pieces Box	İç Kutu Ölç. Inner Box Size	Dış Kutu Ölç. Outer Box Size	Fiyat/Price
	V	Hz	Watt	m ³ /saat	R.p.m.	A	Kg	Kg	Ad.	mm	mm	Usd
GKMS	230	50	460	1.500	2.750	2,60	7,50		1			\$195,00
GKTS	380	50	460	1.500	2.870	1,10	7,50		1			\$175,00

TEKNİK ÇİZİM | TECHNICAL DRAWING

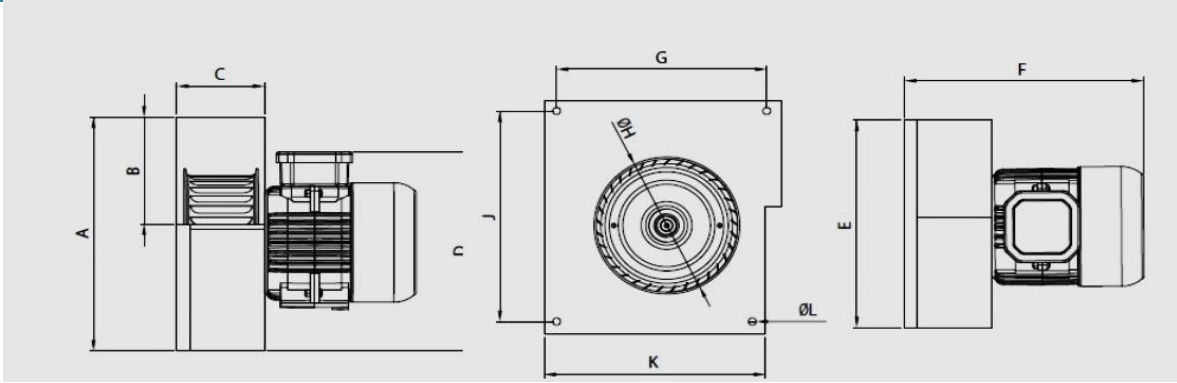

TEKNİK ÖLÇÜLER | TECHNICAL DIMENSIONS

Tüm Ölçüler mm'dir. | All dimensions are in mm

Tip / Type	A	B	C	D	E	F	G	H	J	K	L
GKMS-GKTS	278	114	106	231	248	282	198	178	235	238	8

PERFORMANS VERİLERİ | PERFORMANCE DATA

GKM

GKTS

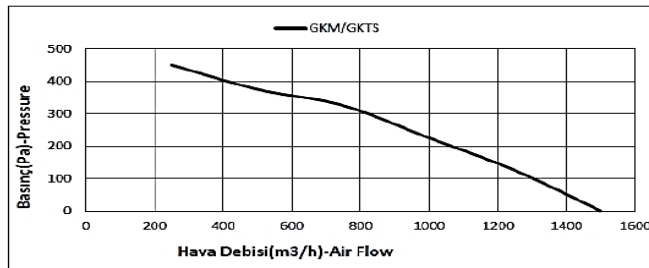



GCES-GOÇES ÇİFT EMİŞLİ RADYAL FANLAR

Radial Fans (metal body)

FAN VERİLERİ | DATA

Tip/Typ	Voltaj Voltage	Frekans	Güç Power	Debi Air Flow	Devir Speed	Akım Current	Ağırlık Weight Net	Ağırlık Weight Gross	Pieces Box	İç Kutu Ölç. Inner Box Size	Dış Kutu Ölç. Outer Box Size	Fiyat/Price
	V	Hz	Watt	m³/saat	R.p.m.	A	Kg	Kg	Ad.	mm	mm	Usd
GCES	230/380	50	217	1.300	1.420	1,10	9,00		1			\$220,00
GOÇES	230/380	50	217	2.200	1.420	1,10	9,00		1			\$240,00

TEKNİK ÇİZİM | TECHNICAL DRAWING

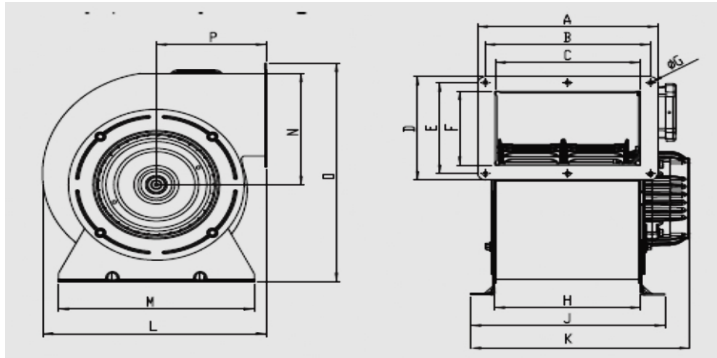

GCES

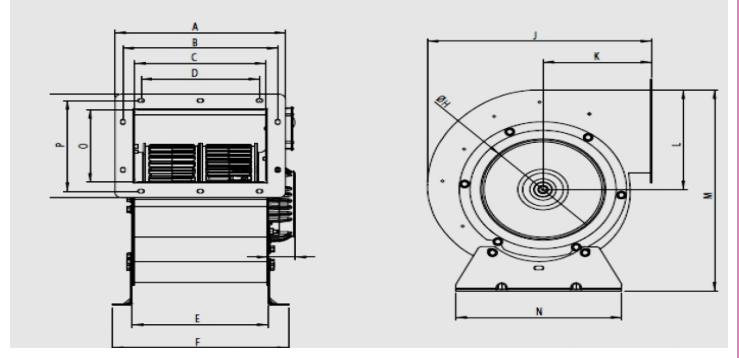

GOÇES

TEKNİK ÖLÇÜLER | TECHNICAL DIMENSIONS

Tüm Ölçüler mm'dir. | All dimensions are in mm

Tip / Type	A	B	C	D	E	F	G	H	J	K	L	M	N	O	P	R
GCES	232	213	187	155	137	111	7	188	250	282	288	252	167	328	142	
GOÇES	258	234	197	180	210	269	41	190	339	160	189	396	252	133	169	194

PERFORMANS VERİLERİ | PERFORMANCE DATA

GCES

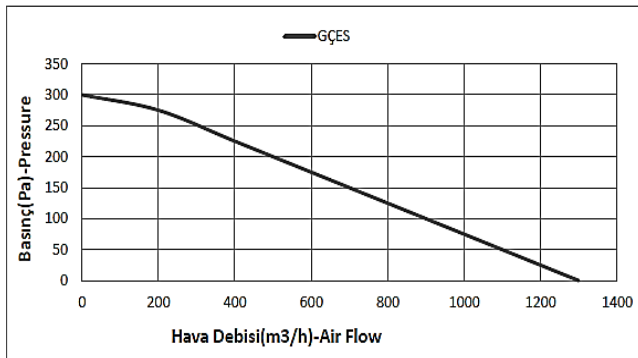

GOÇES

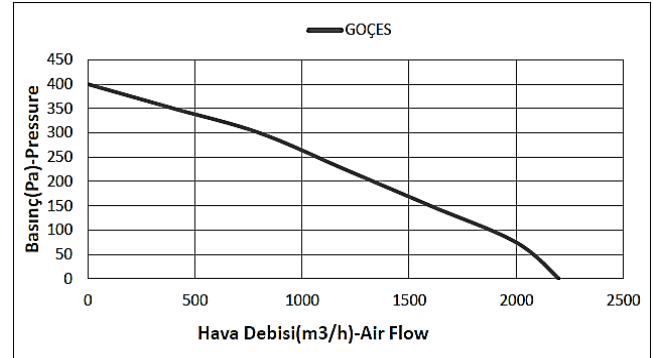



GHF HÜCRELİ FANLAR(SIK KANAT)

Cell Fans (frequent wing)

FAN VERİLERİ | DATA

Tip/Typ	Voltaj Voltage	Frekans	Güç Power	Debi Air Flow	Basınç/ Pressure	Devir Speed	Ürün ölçüleri/Product sizes	Fiyat/Price
	V	Hz	Kw	m³/saat	Pa	R.p.m.	Uzunluk(L)*Yükseklik(H)* Genişlik(W)	Usd
							mm	
GHF 7	230/380	50	0,75	2.500	400	1400	800x600x700	\$1.390,00
GHF 9-A	230/380	50	1,10	3.500	400	1400	800x700x700	\$1.540,00
GHF 9-B	230/380	50	1,50	4.000	400	1400	800x700x700	\$1.670,00
GHF 10-A	230/380	50	1,50	5.000	400	1400	900x700x700	\$1.800,00
GHF 10-B	230/380	50	2,20	6.000	400	1400	900x700x700	\$1.926,00
GHF 12-A	230/380	50	2,20	7.500	400	1400	1000x800x800	\$2.120,00
GHF 12-B	230/380	50	3,00	8.500	400	1400	1000x800x800	\$2.160,00
GHF 15-A	380	50	3,00	10.000	400	1400	1100x1000x1000	\$2.570,00
GHF 15-B	380	50	4,00	12.000	400	1400	1100x1000x1000	\$2.825,00
GHF 15-C	380	50	5,50	14.000	400	1400	1100x1000x1000	\$3.082,00
GHF 18-A	380	50	5,50	16.000	400	1400	1200x1200x1000	\$3.405,00
GHF 18-B	380	50	7,50	20.000	400	1400	1200x1200x1000	\$3.660,00
GHF 450	380	50	7,50	22.000	400	1400	1400x1400x1200	\$4.750,00
GHF 500	380	50	11,00	25.000	500	1400	1600x1400x1400	\$5.155,00
GHF 560-A	380	50	11,00	30.000	600	1400	1700x1500x1500	\$6.470,00
GHF 560-B	380	50	15,00	35.000	600	1400	1700x1500x1500	\$6.755,00

YÖN TABLOLARI / DIRECTION TABLE

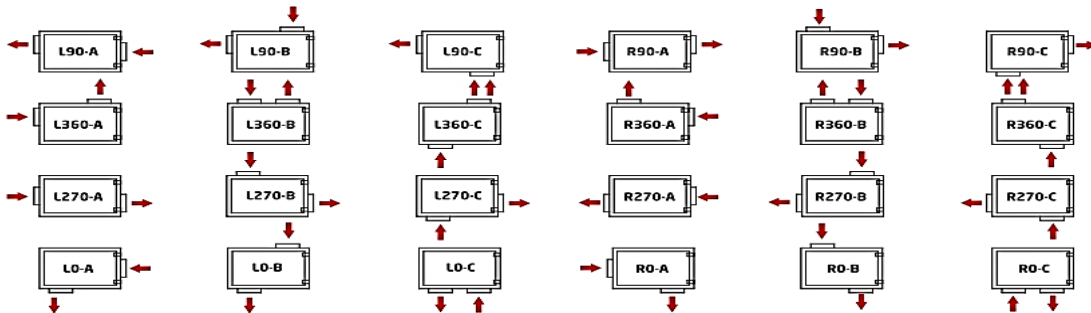



GHFS HÜCRELİ FANLAR(SEYREK KANAT)

Cell Fans (sparse wing)

FAN VERİLERİ | DATA

Tip/Typ	Voltaj Voltage	Frekans	Güç Power	Debi Air Flow	Basınç/ Pressure	Devir Speed	Ürün ölçüleri/Product sizes Uzunluk(L)*Yükseklik(H)* Genişlik(W)	Fiyat/Price
	V	Hz	Kw	m³/saat	Pa	R.p.m.	mm	Usd
GHFS 280 B	230/380	50	2,20	6.000	400	1400	1000x800x800	\$2.700
GHFS 315 A	230/380	50	2,20	7.200	500	1400	1100x900x900	\$2.440
GHFS 315 B	230/380	50	3,00	8.500	500	1400	1100x900x900	\$2.700
GHFS 355 A	230/380	50	3,00	10.000	500	1400	1200x1000x1000	\$3.020
GHFS 355 B	380	50	4,00	12.000	500	1400	1200x1000x1000	\$3.210
GHFS 400 A	380	50	5,50	13.500	500	1400	1300x1100x1100	\$3.790
GHFS 400 B	380	50	7,50	15.000	700	1400	1300x1100x1100	\$4.110
GHFS 450	380	50	7,50	18.000	600	1400	1400x1200x1200	\$4.815
GHFS 500	380	50	11,00	21.000	600	1400		\$6.165
GHFS 560 A	380	50	11,00	25.000	600	1400	1700x1500x1500	\$7.705
GHFS 560 B	380	50	15,00	30.000	700	1400	1700x1500x1500	\$8.350



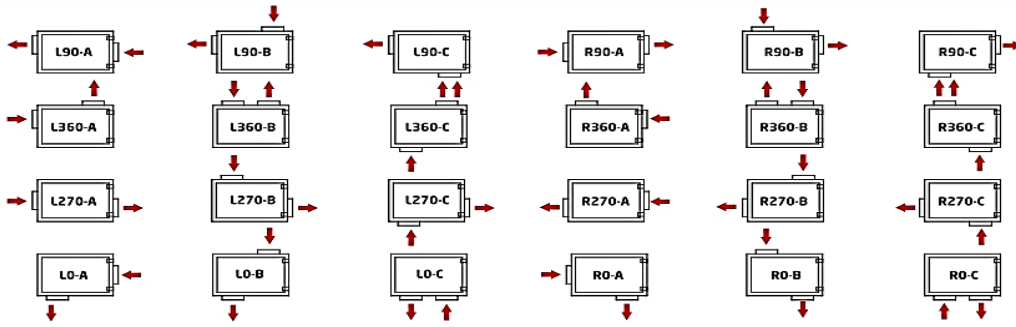

YÖN TABLOLARI / DIRECTION TABLE

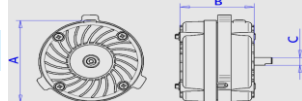

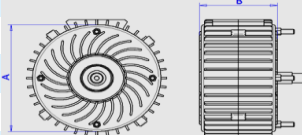

YEDEK PARÇALAR / SPARE PARTS
ELEKTRİK MOTORLARI

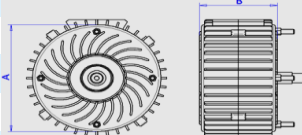
Tip	Kullanılan Kapaklı Baca Fanı	Voltaj	Frekans	Güç	Devir	Akım	Teknik Ölçüler (mm)			Teknik Çizim	Fiyat
		V	Hz	Watt	R.p.m.	A	A	B	C	mm	Usd
	16-20	220	50	40	1.400	0,23	82	54	8		\$47,00
	25-30	220	50	50	1400	0,35	82	78	8		\$52,00
	35	220	50	60	1.400	0,40	82	88	8		\$59,00

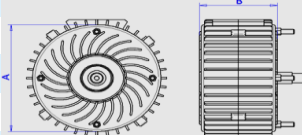
ELEKTRİK MOTORLARI

Tip	Kullanılan Sanayi Fanı	Voltaj	Frekans	Güç	Devir	Akım	Teknik Ölçüler (mm)			Teknik Çizim	Fiyat
		V	Hz	Watt	R.p.m.	A	A	B	C	mm	Usd
	25-30-35	220	50	80	1.400	0,57	147	84	12		\$106,00
	40	220	50	140	1.400	0,97	147	88	12		\$111,00
	45	220	50	100	1.400	1,00	147	88	12		\$118,00
	50	220	50	145	1.400	0,70	147	94	12		\$124,00
	60	220	50	214	1.400	1,18	147	94	12		\$130,00
	GAV	220	50	210	1.400	0,95	158	96	16		\$175,00
	1400	220	50	90	1.400	0,39	177	160	14		\$175,00
	2800	220	50	250	2.800	1,30	177	160	14		\$175,00
	25-30-35	380	50	75	1.400	0,40	147	84	12		\$107,00
	40	380	50	130	1400	0,52	147	88	12		\$112,00
	45	380	50	90	1400	0,57	147	88	12		\$119,00
	50	380	50	140	1400	0,60	147	94	12		\$125,00
	60	380	50	155	1400	0,92	147	94	12		\$131,00
	1400	380	50	85	1400	0,65	177	160	14		\$176,00
2800	380	50	240	2800	0,70	177	160	14	\$176,00		















HIZ ANAHTARI

Tip	Ürün Özellikleri	Teknik Ölçüler(mm)			Fiyat/ Usd
	• Motoru 2kw 8 Ampere kadar olan tüm fanlarda kullanılır.	115	65	45	\$36,00
					\$55,00

HAREKETLİ AYARLI PANJUR

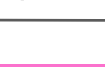
Tip	Ürün Özellikleri	Teknik Ölçüler(mm)			Fiyat/ Usd
	• 110 mm / 120 mm ve 150 mm olarak ayarlanabilir	180	180	47	\$9,00

PERVANE VE DİĞER

Tip	Kullanılan Fan	Ürün Özellikleri	Fiyat Usd	Tip	Kullanılan Fan	Ürün Özellikleri	Fiyat/ Usd
	GB-GK16		\$7,00		GM-GT25		\$15,00
	GB-GK20	Dkp sac, elektrostatik boya, plastik yıldız	\$8,00		GM-GT30		\$17,00
	GB-GK25		\$9,00		GM-GT35	Galvaniz sac, yekpare alüminyum yıldız ve göbek	\$19,50
	GB30	Galvaniz sac, zamak yıldız	\$13,00		GM-GT40		\$21,00
	GB35		\$14,00		GM-GT45		\$22,00
		Vantilatör Duvar Askı Aparatı Takımı	\$52,00		GM-GT50		\$28,00
		Vantilatör ayak Takımı	\$120,00		GM-GT60	Galvaniz sac, galvaniz yıldız, demir göbek	\$33,00
		25-30-35 cm Fan Izgara Takımı	\$11,00		GBS60		\$33,00
		40-45 cm Fan Izgara Takımı	\$16,00		GSF	Vantilatör Pervanesi	\$50,00
		50-60 cm Fan Izgara Takımı	\$25,00				
		GAV600-750 cm Fan Izgara Takımı	\$55,00				

GÜÇTAY®

ELEKTRİK SANAYİ VE TİCARET A.Ş.



ŞEKERPINAR MAH. BADEM SOK. NO:/A ÇAYIROVA/KOCAELİ
TEL:0216 365 13 65-313 71 38

www.guctay.com.tr